

**UNITED STATES  
SECURITIES AND EXCHANGE COMMISSION  
Washington, D.C. 20549**

**FORM S-3  
REGISTRATION STATEMENT  
UNDER THE SECURITIES ACT OF 1933**

**American Superconductor Corporation**

(Exact Name of Registrant as Specified in Its Charter)

**Delaware**  
(State or Other Jurisdiction of Incorporation or Organization)

**04-2959321**  
(I.R.S. Employer Identification Number)

**Two Technology Drive  
Westborough, Massachusetts 01581-1727  
(508) 836-4200**  
(Address, Including Zip Code, and Telephone Number, Including Area Code, of Registrant's Principal Executive Offices)

**Gregory J. Yurek  
Chairman and Chief Executive Officer  
American Superconductor Corporation  
Two Technology Drive  
Westborough, Massachusetts 01581-1727  
(508) 836-4200**  
(Name, Address, Including Zip Code, and Telephone Number, Including Area Code, of Agent for Service)

*Copies to:*

**Patrick J. Rondeau, Esq.  
Wilmer Cutler Pickering Hale and Dorr LLP  
60 State Street  
Boston, Massachusetts 02109  
Telephone: (617) 526-6000  
Telecopy: (617) 526-5000**

**William C. Rogers, Esq.  
Choate, Hall & Stewart  
Exchange Place, 53 State Street  
Boston, Massachusetts 02109  
Telephone: (617) 248-5000  
Telecopy: (617) 248-4000**

Approximate date of commencement of proposed sale to the public: As soon as practicable after the effective date hereof.

If the only securities being registered on this form are being offered pursuant to dividend or interest reinvestment plans, please check the following box.

If any of the securities being registered on this form are to be offered on a delayed or continuous basis pursuant to Rule 415 under the Securities Act of 1933, other than securities offered only in connection with dividend or interest reinvestment plans, check the following box.

If this form is filed to register additional securities for an offering pursuant to Rule 462(b) under the Securities Act, please check the following box and list the Securities Act registration statement number of the earlier effective registration statement for the same offering.  \_\_\_\_\_

If this form is a post-effective amendment filed pursuant to Rule 462(c) under the Securities Act, check the following box and list the Securities Act registration statement number of the earlier effective registration statement for the same offering.  \_\_\_\_\_

If delivery of the prospectus is expected to be made pursuant to Rule 434, please check the following box.

**CALCULATION OF REGISTRATION FEE**

Title of each class of securities to be registered	Amount to be Registered	Proposed Maximum Offering Price Per Unit (1)	Proposed Maximum Aggregate Offering Price (1)	Amount of Registration Fee
Common Stock, \$0.01 par value per share (2)	4,600,000(3)	\$ 12.84	\$ 59,064,000	\$ 6,952

- (1) Estimated solely for purposes of calculating the registration fee pursuant to Rule 457(c) under the Securities Act, based on average of high and low price per share of the common stock as reported on the NASDAQ National Market on January 6, 2005.
- (2) Includes rights to purchase shares of common stock pursuant to the Rights Agreement, as amended, between the Registrant and American Stock Transfer & Trust Company, as Rights Agent.
- (3) Includes 600,000 shares of common stock subject to the underwriters' over-allotment option.

**The Registrant hereby amends this Registration Statement on such date or dates as may be necessary to delay its effective date until the Registrant shall file a further amendment which specifically states that this Registration Statement shall thereafter become effective in accordance with Section 8(a) of the Securities Act of 1933 or until the Registration Statement shall become effective on such date as the Commission, acting pursuant to said Section 8(a), may determine.**

[Table of Contents](#)

The information in this prospectus is not complete and may be changed. A registration statement relating to these securities has been filed with the Securities and Exchange Commission. We may not sell these securities until the registration statement filed with the Securities and Exchange Commission is effective. This prospectus is not an offer to sell these securities and it is not soliciting an offer to buy these securities in any state where the offer or sale is not permitted.

SUBJECT TO COMPLETION, DATED JANUARY 10, 2005

**PROSPECTUS**

4,000,000 Shares



Common Stock

We are offering 4,000,000 shares of our common stock. Our common stock is traded on the NASDAQ National Market under the symbol "AMSC". The last reported sale price of our common stock on January 6, 2005 on the NASDAQ National Market was \$12.92 per share.

Investing in our common stock involves risks. See "[Risk Factors](#)" beginning on page 5.

	Per Share	Total
Public Offering Price	\$	\$
Underwriting Discounts	\$	\$
Proceeds, before expenses, to American Superconductor	\$	\$

The underwriters have a 30-day option to purchase up to an additional 600,000 shares of common stock from us to cover over-allotments.

Neither the Securities and Exchange Commission nor any state securities commission has approved or disapproved of these securities or determined if this prospectus is truthful or complete. Any representation to the contrary is a criminal offense.

Needham & Company, Inc.

William Blair & Company

RBC Capital Markets

The date of this prospectus is \_\_\_\_\_, 2005.



Second Generation  
4-centimeter Technology

Second generation (2G) high temperature superconductor (HTS) wire - now moving to the pre-pilot manufacturing stage at AMSC - is the basis for accelerating the adoption of HTS electricity solutions for the utility, industrial, transportation, defense and medical sectors.



We are helping to create secure power networks - controllable, high capacity, self-protecting electrical grids - through the application of our HTS wire and advanced power electronic systems.



Our power quality solutions increase productivity and yield by delivering high quality, reliable power to manufacturing operations.



Wind farms are adopting our solutions to meet transmission grid interconnection standards - enabling the wider use of renewable energy sources for generating electricity.



Compact, high efficiency ship propulsion motors and generators that utilize our HTS wire are expected to provide significant economic benefits to the marine industry.



Central Japan Railway is testing our HTS wire for use in the electromagnetic lifting coils of its superconducting magnetically levitated (maglev) train system, which currently holds the world speed record for land-based passenger transport.



TABLE OF CONTENTS

	<u>Page</u>
<a href="#">Prospectus Summary</a>	1
<a href="#">Risk Factors</a>	5
<a href="#">Special Note Regarding Forward-Looking Statements</a>	10
<a href="#">Use of Proceeds</a>	10
<a href="#">Price Range of Common Stock</a>	11
<a href="#">Dividend Policy</a>	11
<a href="#">Capitalization</a>	12
<a href="#">Dilution</a>	13
<a href="#">Selected Consolidated Financial Data</a>	14
<a href="#">Management's Discussion and Analysis of Financial Condition and Results of Operations</a>	16
<a href="#">Business</a>	31
<a href="#">Management</a>	59
<a href="#">Description of Capital Stock</a>	61
<a href="#">Underwriting</a>	63
<a href="#">Legal Matters</a>	65
<a href="#">Experts</a>	65
<a href="#">Where You Can Find More Information</a>	65
<a href="#">Incorporation of Certain Documents by Reference</a>	66
<a href="#">Index to Consolidated Financial Statements</a>	F-1

---

You should rely only on the information contained or incorporated by reference to this prospectus. We have not authorized anyone to provide you with information different from that contained or incorporated by reference to this prospectus. Under no circumstances should the delivery to you of this prospectus or any sale made pursuant to this prospectus create any implication that the information contained in this prospectus is correct as of any time after the date of this prospectus.

## PROSPECTUS SUMMARY

*The following summary highlights the key information contained elsewhere in this prospectus. It does not contain all the information that may be important to you. You should read this entire prospectus carefully, especially the discussion of “Risk Factors” and our selected consolidated financial statements and related notes, before deciding to invest in shares of our common stock. In this prospectus, when we use phrases such as “we,” “our” and “us,” we are referring to American Superconductor Corporation and its subsidiaries as a whole, except where it is clear from the context that any of these terms refers only to American Superconductor Corporation. Unless otherwise indicated, the information in this prospectus assumes the underwriters do not exercise their over-allotment option.*

### American Superconductor

#### Overview

We are a leading electricity solutions company. We develop and manufacture products to dramatically improve the cost, efficiency and reliability of systems that generate, deliver and use electric power. Our products include high temperature superconductor (HTS) wire for electric power, transportation, medical and industrial processing applications; motors and generators based on our HTS wire for ship propulsion and industrial uses, as well as synchronous condensers for transmission and distribution grid reliability; and advanced power electronic systems that ensure the quality and reliability of electricity for residential, commercial and industrial end users.

Our HTS wire carries direct current (DC) without any loss of electrical power, resulting in high electrical efficiency. Our HTS wire also conducts more than 140 times the electrical current of copper wire of the same dimensions, which dramatically reduces the size and weight of electrical equipment made with our HTS wire and significantly increases the power throughput of power cables.

#### Second Generation (2G) HTS Wire: Key to Growth

The first generation (1G) HTS wire we are manufacturing and selling today to customers in 11 countries around the world has been critical to the development of large-scale superconductor applications, such as power transmission cables, electrical motors and generators for marine propulsion, synchronous condensers for grid reliability, and HTS coils for magnetically levitated train systems, analytical instruments and industrial processing equipment.

Our strategy is to migrate from our 1G HTS wire to our 2G HTS wire over the next several years. We expect the electrical performance and mechanical strength of our 2G HTS wire to meet or exceed that of 1G HTS wire, while manufacturing costs are reduced by a factor of two to five times. We have also designed our 2G HTS wire to be a “form, fit and function” replacement for our 1G HTS wire. Based on 2G HTS wire’s improved performance, substantially lower manufacturing costs and ease of replacement for 1G HTS wire, we expect markets to rapidly adopt products based on 2G HTS wire as soon as it is available in commercial quantities. During the last year, we have made significant technical and manufacturing advances on our proprietary 2G HTS wire. Accordingly, we have concluded that now is the time to invest in the scale-up of 2G HTS wire manufacturing and to accelerate the transition from 1G to 2G HTS wire.

#### Markets for our Products

Our current and planned products are sold or planned to be sold to electric utilities and transmission and distribution grid operators, electrical equipment manufacturers, industrial power users and shipbuilders that utilize electric motors for ship propulsion systems. Our technology and products are backed by an intellectual

## Table of Contents

property portfolio that as of December 31, 2004 includes more than 390 patents and patent applications owned by us worldwide and more than 375 patents and patent applications licensed from others worldwide.

Our products, and those sold by others who incorporate our products, can:

- increase the reliability, security, and power transfer capacity of electricity transmission and distribution power grids;
- improve the quality of electric power delivered to manufacturing plants;
- meet the grid interconnection standards required by wind farms and other sources of renewable energy;
- reduce the manufacturing and operating costs of primary electrical equipment, including motors and generators;
- reduce the size and weight of power cables, motors, generators, and other electric power equipment; and
- conserve energy resources used to produce electricity, such as oil, gas and coal, by more efficiently conducting and converting electricity into useful forms.

We believe there will be significant market demand for our products because of the following factors:

- demand for electric power continues to grow on a global basis;
- the power grids in the U.S. and in many developed nations face severe constraints in adequately and safely delivering the amounts of power demanded by electric power users;
- power reliability and power quality are increasingly important as economies transition to computerized and digitized systems;
- U.S. domestic policy is now addressing the need to upgrade the transmission and distribution power grid as part of an effective long-term national energy policy; and
- Environmental threats from global industrialization and population growth continue to influence nations to encourage environmentally friendly power technologies.

We conduct our operations through three business units:

- AMSC Wires, a developer and manufacturer of HTS wire;
- SuperMachines, a designer and manufacturer of rotating machines based on our HTS wire, including electric motors, generators and synchronous condensers; and
- Power Electronic Systems, a designer and manufacturer of power electronic converters and integrated power electronic systems that increase power grid reliability and throughput and ensure high quality power for industrial manufacturing operations.

### **Corporate Information**

Our principal executive offices are located at Two Technology Drive, Westborough, Massachusetts 01581 and our telephone number at that address is (508) 836-4200.

Our website is located at [www.amsuper.com](http://www.amsuper.com). We have not incorporated by reference into this prospectus the information on our website and you should not consider it to be a part of this document. Our website address is included as an inactive textual reference only.

**The Offering**

Common stock offered	4,000,000 shares
Common stock to be outstanding after this offering	31,942,926 shares
Use of Proceeds	We intend to use the net proceeds for working capital and for general corporate purposes, including the scale-up of manufacturing for our 2G HTS wire.
NASDAQ National Market symbol	AMSC

The number of shares of our common stock to be outstanding after this offering is based on the number of shares outstanding as of December 31, 2004 and excludes (a) options to purchase 4,611,386 shares of common stock outstanding as of December 31, 2004, (b) 3,158,569 additional shares of common stock available for future issuance under our stock option plans and (c) outstanding warrants to purchase 86,250 shares of common stock.

**Summary Consolidated Financial Data**  
(in thousands, except per share data)

The following table provides selected financial data for the three fiscal years ended March 31, 2004 and the six months ended September 30, 2003 and 2004.

	Fiscal Year Ended March 31,			Six Months Ended September 30,	
	2002	2003	2004	2003	2004
(unaudited)					
<b>Statement of Operations Data</b>					
Total revenues	\$ 11,650	\$ 21,020	\$ 41,309	\$ 17,371	\$22,183
Total costs and expenses	\$ 73,203	\$ 109,532	\$ 66,995	\$ 31,802	\$31,404
Net loss	\$(56,985)	\$(87,633) <sup>(1)</sup>	\$(26,733)	\$(15,693)	\$(9,030)
Net loss per common share (basic and diluted)	\$ (2.79)	\$ (4.21)	\$ (1.10)	\$ (0.73)	\$ (0.33)
Weighted average number of common shares outstanding (basic and diluted)	20,409	20,831	24,196	21,363	27,742
<b>Other Data</b>					
Research and development expenses	\$ 27,814	\$ 21,940	\$ 14,056	\$ 7,974	\$ 3,636
Pro forma research and development expenses <sup>(2)</sup>	\$ 36,882	\$ 33,447	\$ 41,350	\$ 20,116	\$18,261

- Net loss for the fiscal year ended March 31, 2003 includes an impairment charge of \$39,231 to write down our 1G HTS wire asset group, primarily comprised of the Devens, Massachusetts manufacturing facility and capital equipment, to an estimated fair value.
- Pro forma research and development expenses is a non-GAAP financial measure that consists of research and development expenses plus research and development expenses related to externally funded development contracts included in costs of revenue, and research and development expenses offset by cost-sharing funding under government contracts. We believe that presenting pro forma research and development expenses provides useful information as to our aggregate research and development spending. Please see page 14 of this prospectus for a reconciliation between research and development expenses and pro forma research and development expenses.

	As of September 30, 2004	
	Actual	As Adjusted
(unaudited)		
<b>Balance Sheet Data</b>		
Cash and cash equivalents and marketable securities	\$ 45,655	\$ 93,789
Working capital	46,863	94,997
Total assets	122,882	171,016
Total liabilities	15,099	15,099
Stockholders' equity	107,783	155,917

The as adjusted balance sheet data as of September 30, 2004 gives effect to the sale by us of the 4,000,000 shares of common stock offered under this prospectus, at an assumed public offering price of \$12.92 per share, the last reported sale price of our common stock on January 6, 2005 on the NASDAQ National Market, after deducting the estimated underwriting discounts and commissions and the estimated offering expenses payable by us.



## RISK FACTORS

*An investment in our common stock involves a high degree of risk. You should carefully consider the following risk factors and the other information included or incorporated by reference into this prospectus before investing in our common stock. Additional risks and uncertainties not presently known to us or that we currently deem immaterial may also affect our business operations. If any of these risks occur, our business could suffer, the market price of our common stock could decline and you could lose all or part of your investment in our common stock.*

### **We have a history of operating losses, and we expect to incur losses in the future.**

We have been principally engaged in research and development activities. We have incurred net losses in each year since our inception. Our net loss for the six months ended September 30, 2004 was \$9,030,000, and for the fiscal years ended March 31, 2004, March 31, 2003, and March 31, 2002 was \$26,733,000, \$87,633,000, and \$56,985,000, respectively. Our accumulated deficit as of September 30, 2004 was \$308,873,000. We expect to continue to incur operating losses until at least the end of the fiscal year ending March 31, 2007, and there can be no assurance that we will ever achieve profitability.

We had cash, cash-equivalents and long-term marketable securities totaling \$45,655,000 at September 30, 2004. We believe our available funds, together with the proceeds of this offering, will be sufficient to fund our working capital, capital expenditures, and other cash requirements for at least the next three years. However, we may need additional funds if our performance deviates significantly from our current business plan, if there are significant changes in competitive or other market factors, or if unforeseen circumstances arise. Such funds may not be available, or may not be available under terms acceptable to us.

### **There are a number of technological challenges that must be successfully addressed before our superconductor products can gain widespread commercial acceptance, and our inability to address such technological challenges could adversely affect our ability to acquire customers for our products.**

Many of our products are in the early stages of commercialization, while others are still under development. There are a number of technological challenges that we must successfully address to complete our development and commercialization efforts. We also believe that several years of further development in the cable and motor industries will be necessary before a substantial number of additional commercial applications for our HTS wire in these industries can be developed and proven. We will also need to improve the performance and/or reduce the cost of our HTS wire to expand the number of commercial applications for it. We may be unable to meet such technological challenges. Delays in development, as a result of technological challenges or other factors, may result in the introduction or commercial acceptance of our products later than anticipated.

### **The commercial uses of superconductor products are limited today, and a widespread commercial market for our products may not develop.**

To date, there has been no widespread commercial use of HTS products. Commercial acceptance of low temperature superconductor (LTS) products, other than for medical magnetic resonance imaging and superconductor magnetic energy storage (SMES) products, has been significantly limited by the cooling requirements of LTS materials. Even if the technological hurdles currently limiting commercial uses of HTS and LTS products are overcome, it is uncertain whether a robust commercial market for those new and unproven products will ever develop. It is possible that the market demands we currently anticipate for our HTS and LTS products will not develop and that superconductor products will never achieve widespread commercial acceptance.

**We have limited experience manufacturing our HTS products in commercial quantities, and failure to manufacture our HTS products in commercial quantities at acceptable cost and quality levels would impair our ability to meet customer delivery requirements.**

To be financially successful, we will have to manufacture our HTS products in commercial quantities at acceptable costs while also preserving the necessary performance and quality levels. We cannot make assurances that we will be successful in developing product designs and manufacturing processes that permit us to manufacture our HTS products in commercial quantities at acceptable costs while preserving the necessary performance and quality. In addition, we may incur significant unforeseen expenses in our product design and manufacturing efforts.

Achieving stable yields, production volume and acceptable costs in the commercial manufacturing of 1G HTS wire remains an ongoing challenge. 1G HTS wire manufacturing processes are complex and subtle and must be rigorously controlled and monitored for consistent yields and quality. The failure to manufacture a sufficient quantity of 1G HTS wire at acceptable quality levels and yields would impair our ability to meet customer delivery commitments and adversely affect our financial performance.

**We have never manufactured our 2G HTS wire in commercial quantities, and failure to manufacture our 2G HTS wire in commercial quantities at acceptable cost and quality levels would substantially limit our future revenue and profit potential.**

We are in the early stages of developing our commercial-scale 2G HTS wire manufacturing processes, which, while very different from our 1G HTS wire manufacturing processes, are also extremely complex and challenging. We may not be able to manufacture satisfactory commercial quantities of 2G HTS wire of consistent quality, yield and cost. Failure to successfully scale up manufacturing of our 2G HTS wire would result in a significant limitation of the broad market acceptance of our HTS products and of our future revenue and profit potential.

**We have limited experience in marketing and selling our products, and our failure to effectively market and sell our products could adversely affect our revenue and cash flow.**

To date, we have limited experience marketing and selling our products, and there are few people who have significant experience marketing or selling superconductor products. Once our products are ready for widespread commercial use, we will have to develop a marketing and sales organization that will effectively demonstrate the advantages of our products over both more traditional products and competing superconductor products or other technologies. We may not be successful in our efforts to market this new technology, and we may not be able to establish an effective sales and distribution organization.

We may decide to enter into arrangements with third parties for the marketing or distribution of our products, including arrangements in which our products, such as HTS wire, are included as a component of a larger product, such as a motor. By entering into marketing and sales alliances, the financial benefits to us of commercializing our products are dependent on the efforts of others. We may not be able to enter into marketing or distribution arrangements with third parties on financially acceptable terms, and third parties may not be successful in selling our products or applications incorporating our products.

**Many of our revenue opportunities are dependent upon subcontractors and other business partners.**

Many of the revenue opportunities for our AMSC Wires business unit involve projects, such as the installation of HTS cables in power grids, on which we partner with other companies, including suppliers of cryogenic systems and manufacturers of electric power cables. In addition, a key element of our SuperMachines business strategy is the formation of business alliances with motor manufacturers and/or marine propulsion system integrators. As a result, most of our current and planned revenue-generating projects involve business partners on whose performance our revenue is dependent. If these business partners fail to deliver their products or perform their obligations on a timely basis, our revenue from the project may be delayed or decreased.

## [Table of Contents](#)

**Our contracts with the U.S. government are subject to audit, modification or termination by the U.S. government, and the continued funding of such contracts remains subject to annual congressional appropriation, which if not approved could adversely affect our results of operations and financial condition.**

As a company which contracts with the U.S. government, we are subject to financial audits and other reviews by the U.S. government of our costs and performance, accounting and general business practices relating to these contracts. Based on the results of its audits, the U.S. government may adjust our contract-related costs and fees. No assurances can be given that adjustments arising from government audits and reviews would not have a material adverse effect on our results of operations.

All of our U.S. government contracts can be terminated by the U.S. government for its convenience. Termination for convenience provisions provide only for our recovery of costs incurred or committed, settlement expenses and profit on work completed prior to termination. In addition to the right of the U.S. government to terminate its contract with us, U.S. government contracts are conditioned upon the continuing approval by Congress of the necessary spending to honor such contracts. Congress often appropriates funds for a program on a fiscal-year basis even though contract performance may take more than one year. Consequently, at the beginning of many major governmental programs, contracts often may not be fully funded, and additional monies are then committed to the contract only if, as and when appropriations are made by Congress for future fiscal years. There can be no assurance that our U.S. government contracts will not be terminated or suspended in the future. The U.S. government's termination of, or failure to fully fund, one or more of our contracts would have a negative impact on our operating results and financial condition. Further, in the event that any of our government contracts are terminated for cause, it could affect our ability to obtain future government contracts which could, in turn, seriously harm our ability to develop our technologies and products.

**Our products face intense competition both from superconductor products developed by others and from traditional, non-superconductor products and alternative technologies, which could limit our ability to acquire or retain customers.**

As we begin to market and sell our superconductor products, we will face intense competition both from competitors in the superconductor field and from vendors of traditional products and new technologies. There are many companies in the United States, Europe, Japan and China engaged in the development of HTS wire, including Sumitomo Electric Industries, Intermagnetics General, European Advanced Superconductors, Nexans, Trithor, Fujikura, Furukawa Electric, Showa, and Innova Superconductor Technology. The superconductor industry is characterized by rapidly changing and advancing technology. Our future success will depend in large part upon our ability to keep pace with advancing HTS and LTS technology and developing industry standards. Our SMES products and integrated power electronic products, such as D-VAR, compete with a variety of other products such as dynamic voltage restorers (DVRs), static VAR compensators (SVCs), static compensators (STATCOMS), flywheels, power electronic converters and battery-based power supply systems. Competition for our PowerModules™ includes products from ABB, Alstom, Siemens, Mitsubishi Electric, Ecostar, Inverpower, SatCon, Semikron and Xantrex. The HTS motor and generator products that we are developing face competition from copper wire-based motors and generators, from permanent magnet motors that are being developed, and from companies developing HTS rotating machinery including Siemens, ABB and GE. Research efforts and technological advances made by others in the superconductor field or in other areas with applications to the power quality and reliability markets may render our development efforts obsolete. Many of our competitors have substantially greater financial resources, research and development, manufacturing and marketing capabilities than we have. In addition, as the HTS wire, HTS electric motors and generators, and power electronic systems markets develop, other large industrial companies may enter those fields and compete with us. If we are unable to compete successfully, it may harm our business, which in turn may limit our ability to acquire or retain customers.

**Third parties have or may acquire patents that cover the HTS materials we use or may use in the future to manufacture our products, and our success depends on our ability to license such patents or other proprietary rights.**

We expect that some or all of the HTS materials and technologies we use in designing and manufacturing our products are or will become covered by patents issued to other parties, including our competitors. If that is the case, we will need either to acquire licenses to these patents or to successfully contest the validity of these patents. The owners of these patents may refuse to grant licenses to us, or may be willing to do so only on terms that we find commercially unreasonable. If we are unable to obtain these licenses, we may have to contest the validity or scope of those patents to avoid infringement claims by the owners of these patents. It is possible that we will not be successful in contesting the validity or scope of a patent, or that we will not prevail in a patent infringement claim brought against us. Even if we are successful in such a proceeding, we could incur substantial costs and diversion of management resources in prosecuting or defending such a proceeding.

**Our patents may not provide meaningful protection for our technology, which could result in us losing some or all of our market position.**

We own or have licensing rights under many patents and pending patent applications. However, the patents that we own or license may not provide us with meaningful protection of our technologies and may not prevent our competitors from using similar technologies, for a variety of reasons, such as:

- the patent applications that we or our licensors file may not result in patents being issued;
- any patents issued may be challenged by third parties; and
- others may independently develop similar technologies not protected by our patents or design around the patented aspects of any technologies we develop.

Moreover, we could incur substantial litigation costs in defending the validity of our own patents. We also rely on trade secrets and proprietary know-how to protect our intellectual property. However, our non-disclosure agreements and other safeguards may not provide meaningful protection for our trade secrets and other proprietary information. If the patents that we own or license or our trade secrets and proprietary know-how fail to protect our technologies, our market position may be adversely affected.

**Our success is dependent upon attracting and retaining qualified personnel, and our inability to do so could significantly damage our business and prospects.**

Our success will depend in large part upon our ability to attract and retain highly qualified research and development, management, manufacturing, marketing and sales personnel. Hiring those persons may be especially difficult due to the specialized nature of our business.

**We may in the future acquire complementary businesses or technologies, which may require us to incur substantial costs for which we may never realize the anticipated benefits.**

We may in the future acquire complementary businesses or technologies, although we currently have no commitments or agreements and are not involved in any negotiations with respect to any specific acquisitions. If we do pursue acquisitions, management's attention and resources may be diverted from other business concerns. An acquisition may also involve a significant purchase price and significant transaction-related expenses.

Achieving the benefits of any acquisition would involve additional risks, including:

- difficulty assimilating acquired operations, technologies and personnel;
- inability to retain management and other key personnel of the acquired business;

---

## [Table of Contents](#)

- changes in management or other key personnel that may harm relationships with the acquired business's customers and employees; and
- diversion of management attention as a result of the integration process.

If we do pursue acquisitions, we cannot ensure that we will realize any of the anticipated benefits of any acquisition, and if we fail to realize these anticipated benefits, our operating performance could suffer.

**Our common stock may experience extreme market price and volume fluctuations, which may prevent our stockholders from selling our common stock at a profit and could lead to costly litigation against us that could divert our management's attention.**

The market price of our common stock has historically experienced significant volatility and may continue to experience such volatility in the future. Factors such as technological achievements by us and our competitors, the establishment of development or strategic relationships with other companies, our introduction of commercial products, and our financial performance may have a significant effect on the market price of our common stock. In addition, the stock market in general, and the stock of high technology companies in particular, have in recent years experienced extreme price and volume fluctuations, which are often unrelated to the performance or condition of particular companies. Such broad market fluctuations could adversely affect the market price of our common stock. Due to these factors, the price of our common stock may decline and investors may be unable to resell their shares of our common stock for a profit. Following periods of volatility in the market price of a particular company's securities, securities class action litigation has often been brought against that company. If we become subject to this kind of litigation in the future, it could result in substantial litigation costs, a damages award against us and the diversion of our management's attention.

## **SPECIAL NOTE REGARDING FORWARD-LOOKING STATEMENTS**

This prospectus, any prospectus supplement we may use in connection with this prospectus, and the documents we incorporate by reference into this prospectus contain forward-looking statements within the meaning of Section 21E of the Securities Exchange Act of 1934 and Section 27A of the Securities Act of 1933. For this purpose, any statements contained herein that relate to future events or conditions, including without limitation, the statements included or incorporated by reference into this prospectus regarding industry prospects and our prospective results of operations or financial position, may be deemed to be forward-looking statements. The words “believes,” “anticipates,” “plans,” “expects,” and similar expressions are intended to identify forward-looking statements. Such forward-looking statements represent management’s current expectations and are inherently uncertain. The important factors discussed above under “Risk Factors,” among others, could cause actual results to differ materially from those indicated by such forward-looking statements. Any such forward-looking statements represent management’s views as of the date of the document in which such forward-looking statement is contained. While we may elect to update such forward-looking statements at some point in the future, we disclaim any obligation to do so, even if subsequent events cause our views to change.

## **USE OF PROCEEDS**

We estimate the net proceeds to us of this offering to be approximately \$48.1 million, based on an assumed public offering price of \$12.92 per share, the last reported sale price of our common stock on January 6, 2005 on the NASDAQ National Market, after deducting the estimated underwriting discounts and commissions and the estimated offering expenses payable by us.

We intend to use the net proceeds from this offering primarily for working capital and for general corporate purposes, including capital expenditures for the scale-up of manufacturing for our 2G HTS wire. The equipment cost for the pilot line of our 2G HTS wire is expected to be \$10 to \$15 million. Additional equipment needed for full commercial production of our 2G HTS wire is expected to cost approximately \$25 to \$30 million.

The amounts actually spent by us for any specific purpose may vary significantly and will depend on a number of factors, including the progress of our commercialization and development efforts. Accordingly, our management has broad discretion to allocate the net proceeds. Pending the uses described above, we intend to invest the net proceeds of this offering in short-term, interest-bearing, investment-grade securities.

### PRICE RANGE OF COMMON STOCK

Our common stock has been quoted on the NASDAQ National Market under the symbol “AMSC” since 1991. The following table sets forth the high and low sale prices per share of our common stock as reported on the NASDAQ National Market for the periods indicated.

	<u>High</u>	<u>Low</u>
Fiscal Year Ended March 31, 2003		
First Quarter	\$ 8.87	\$ 3.85
Second Quarter	6.05	2.65
Third Quarter	4.24	2.10
Fourth Quarter	5.41	3.02
Fiscal Year Ended March 31, 2004		
First Quarter	7.35	3.18
Second Quarter	13.85	4.95
Third Quarter	14.67	9.10
Fourth Quarter	19.95	11.29
Fiscal Year Ending March 31, 2005		
First Quarter	15.07	10.90
Second Quarter	13.36	9.01
Third Quarter	15.13	10.52
Fourth Quarter (through January 6, 2005)	14.98	12.44

A recent last reported sale price per share for our common stock on the NASDAQ National Market is set forth on the cover page of this prospectus.

### DIVIDEND POLICY

We have never paid cash dividends on our common stock. We currently intend to retain earnings, if any, to fund the development and growth of our business and do not anticipate paying cash dividends for the foreseeable future. Payment of future cash dividends, if any, will be at the discretion of our board of directors after taking into account various factors, including our financial condition, operating results, current and anticipated cash needs and plans for expansion.

## CAPITALIZATION

The following table sets forth our capitalization as of September 30, 2004:

- on an actual basis; and
- on an as adjusted basis to reflect the issuance and sale of 4,000,000 shares of our common stock in this offering at the assumed public offering price of \$12.92 per share, the last reported sale price of our common stock on January 6, 2005 on the NASDAQ National Market, after deducting the estimated underwriting discounts and commissions and the estimated offering expenses payable by us.

This table excludes 4,837,665 shares of our common stock reserved as of September 30, 2004 for issuance upon exercise of outstanding options and warrants. You should read this table together with our financial statements and accompanying notes and with “Management’s Discussion and Analysis of Financial Condition and Results of Operations” appearing elsewhere in this prospectus.

	As of September 30, 2004	
	Actual	As Adjusted
	(in thousands) (unaudited)	
Long-term debt	—	—
Stockholders’ equity:		
Common stock, \$0.01 par value; 100,000,000 shares authorized; 27,774,902 shares issued and outstanding, actual; 31,774,902 shares issued and outstanding, as adjusted	\$ 278	\$ 318
Additional paid-in capital	417,471	465,565
Deferred compensation	(987)	(987)
Deferred warrant costs	(29)	(29)
Accumulated other comprehensive loss	(77)	(77)
Accumulated deficit	(308,873)	(308,873)
Total stockholders’ equity	107,783	155,917
Total capitalization	\$ 107,783	\$ 155,917



## DILUTION

Our net tangible book value as of September 30, 2004 was approximately \$101,019,000, or \$3.64 per share. Net tangible book value per share represents our total tangible assets less our total liabilities, divided by the aggregate number of shares of our common stock outstanding. After giving effect to the sale of the 4,000,000 shares of our common stock in this offering, at an assumed public offering price of \$12.92 per share, the last reported sale price of our common stock on January 6, 2005 on the NASDAQ National Market, after deducting the estimated underwriting discounts and commissions and the estimated offering expenses payable by us, our net tangible book value at September 30, 2004 would have been approximately \$149,153,000 or \$4.69 per share. This represents an immediate increase in net tangible book value per share of \$1.05 to existing stockholders and an immediate dilution of \$8.23 per share to new investors. Dilution per share represents the difference between the amount per share paid by the new investors in this offering and the net tangible book value per share at September 30, 2004, giving effect to this offering. The following table illustrates this per share dilution to new investors.

Public offering price per share		\$12.92
Net tangible book value per share as of September 30, 2004	\$3.64	
Increase in net tangible book value per share attributable to new investors	1.05	
	<hr/>	
Net tangible book value per share after this offering		4.69
	<hr/>	
Dilution per share to new investors		\$ 8.23
		<hr/>

These calculations assume no exercise of stock options and warrants outstanding as of September 30, 2004. As of September 30, 2004, there were options and warrants outstanding to purchase an aggregate of 4,837,665 shares of our common stock at a weighted average exercise price of \$14.82 per share. To the extent all of these options and warrants had been exercised as of September 30, 2004, the dilution to new investors would be greater.

## SELECTED CONSOLIDATED FINANCIAL DATA

The selected consolidated financial data presented below for the fiscal years ended March 31, 2000, 2001, 2002, 2003 and 2004 have been derived from our consolidated financial statements that have been audited by PricewaterhouseCoopers LLP, independent registered public accounting firm. The selected consolidated financial data for the six months ended September 30, 2003 and 2004 and as of September 30, 2004 have been derived from our unaudited consolidated financial statements. In the opinion of our management, such unaudited consolidated financial statements have been prepared on the same basis as the audited consolidated financial statements and include all adjustments, consisting only of normal recurring adjustments, necessary for a fair presentation of our operating results and financial position for such periods and as of such date. Our operating results for the six months ended September 30, 2004 are not necessarily indicative of the results to be expected for the entire fiscal year ending March 31, 2005. The financial data presented below should be read in conjunction with the other financial information appearing elsewhere in this prospectus or incorporated by reference into this prospectus.

	Fiscal Year Ended March 31,					Six Months Ended September 30,	
	2000	2001	2002	2003	2004	2003	2004
<b>(in thousands, except per share data)</b>							
<b>Statement of Operations Data</b>							
<b>Revenues:</b>							
Contract revenue	\$ 10,439	\$ 3,186	\$ 2,111	\$ 715	\$ 875	\$ 554	\$ 655
Product sales and prototype development contracts	4,674	13,582	9,539	20,305	40,434	16,817	21,528
<b>Total revenues</b>	<b>15,113</b>	<b>16,768</b>	<b>11,650</b>	<b>21,020</b>	<b>41,309</b>	<b>17,371</b>	<b>22,183</b>
<b>Costs and expenses:</b>							
Costs of revenue – contract revenue	10,325	3,135	2,101	684	825	522	697
Cost of revenue – product sales and prototype development contracts	4,369	10,981	17,299	31,518	43,455	18,233	22,530
Research and development	13,206	22,832	27,814	21,940	14,056	7,974	3,636
Selling, general and administrative	6,686	14,215	16,313	16,159	8,659	5,073	4,541
Pirelli license costs	—	—	4,010	—	—	—	—
Restructuring charges	—	—	5,666	—	—	—	—
Impairment charge	—	—	—	39,231	—	—	—
<b>Total costs and expenses</b>	<b>34,586</b>	<b>51,163</b>	<b>73,203</b>	<b>109,532</b>	<b>66,995</b>	<b>31,802</b>	<b>31,404</b>
<b>Operating loss</b>	<b>(19,473)</b>	<b>(34,395)</b>	<b>(61,553)</b>	<b>(88,512)</b>	<b>(25,686)</b>	<b>(14,431)</b>	<b>(9,221)</b>
Interest income	1,871	12,555	4,451	869	296	82	303
Fees – abandoned debt financing	—	—	—	—	(1,388)	(1,356)	(35)
Other income (expense), net	4	164	117	10	45	12	(77)
<b>Net loss</b>	<b>\$ (17,598)</b>	<b>\$ (21,676)</b>	<b>\$ (56,985)</b>	<b>\$ (87,633)</b>	<b>\$ (26,733)</b>	<b>\$ (15,693)</b>	<b>\$ (9,030)</b>
<b>Net loss per common share (basic and diluted)</b>	<b>\$ (1.11)</b>	<b>\$ (1.08)</b>	<b>\$ (2.79)</b>	<b>\$ (4.21)</b>	<b>\$ (1.10)</b>	<b>\$ (0.73)</b>	<b>\$ (0.33)</b>
<b>Weighted average number of common shares outstanding (basic and diluted)</b>	<b>15,820</b>	<b>20,127</b>	<b>20,409</b>	<b>20,831</b>	<b>24,196</b>	<b>21,363</b>	<b>27,742</b>
<b>Other Data</b>							
Research and development expenses	\$ 13,206	\$ 22,832	\$ 27,814	\$ 21,940	\$ 14,056	\$ 7,974	\$ 3,636
Research and development expenditures classified as cost of revenues	8,412	5,879	8,757	10,997	25,442	11,439	13,967
Research and development expenditures offset by cost-sharing funding	1,014	135	311	510	1,852	703	658
<b>Pro forma research and development expenses<sup>(1)</sup></b>	<b>\$ 22,632</b>	<b>\$ 28,846</b>	<b>\$ 36,882</b>	<b>\$ 33,447</b>	<b>\$ 41,350</b>	<b>\$ 20,116</b>	<b>\$ 18,261</b>

(1) Pro forma research and development expenses is a non-GAAP financial measure that consists of research and development expenses plus research and development expenses related to externally funded development contracts included in costs of revenue, and research and development expenses offset by cost-sharing funding under government contracts. We believe that presenting pro forma research and development expenses provides useful information as to our aggregate research and development spending.

[Table of Contents](#)

	As of March 31,					As of
	2000	2001	2002	2003	2004	September 30,
						2004
<b>Balance Sheet Data</b>						(unaudited)
						(in thousands)
Cash and cash equivalents and marketable securities	\$ 218,655	\$ 160,225	\$ 68,200	\$ 20,049	\$ 52,647	\$ 45,655
Working capital	135,681	108,808	36,834	19,407	46,202	46,863
Total assets	248,914	239,927	197,795	101,979	129,899	122,882
Total long-term debt	—	—	—	—	—	—
Stockholders' equity	240,944	227,564	172,166	87,819	115,452	107,783

## MANAGEMENT'S DISCUSSION AND ANALYSIS OF FINANCIAL CONDITION AND RESULTS OF OPERATIONS

### Executive Overview

We were founded in 1987. We are focused on developing, manufacturing and selling products using two core technologies: high temperature superconductor (HTS) wires and power electronic converters for electric power applications. We also assemble superconductor wires and power electronic converters into fully integrated products, such as HTS ship propulsion motors and dynamic reactive compensation systems, which we sell or plan to sell to end users. Current or prospective customers for our products include electric utilities, electrical equipment manufacturers, industrial power users and commercial and military shipbuilders.

Our HTS wire addresses constraints on the power grids in the U.S. and other developed countries by increasing the electric current carrying capacity of the transmission cables comprising these power grids. In addition, our HTS wire, when incorporated into primary electrical equipment such as motors and generators, can provide increased manufacturing and operating savings due to a significant reduction in size and weight of this equipment. Also, our power electronic converters increase the quality and reliability of electric power that is transmitted by electric utilities or consumed by large industrial entities.

Our products are in varying stages of commercialization. Our power electronic converters have been sold commercially, as part of an integrated system, to utilities, manufacturers and wind farm owners since 1999. Our HTS wire has been produced commercially since the beginning of 2003, although its principal applications (power cables, rotating machines, specialty magnets) are currently in the prototype stage. Some of these prototypes are funded by U.S. government contracts, primarily with the Department of Defense and Department of Energy.

Our cash requirements depend on numerous factors, including successful completion of our product development activities, ability to commercialize our product prototypes, rate of customer and market adoption of our products and the continued availability of U.S. government funding during the product prototype phase. Significant deviations to our business plan with regard to these factors, which are important drivers to our business, could have a material adverse effect on our operating performance, financial condition, and future business prospects. We expect to pursue the expansion of our operations through internal growth and strategic alliances.

### Critical Accounting Policies and Estimates

The preparation of consolidated financial statements requires that we make estimates and judgments that affect the reported amounts of assets, liabilities, revenue and expenses, and related disclosure of contingent assets and liabilities. We base our estimates on historical experience and various other assumptions that are believed to be reasonable under the circumstances, the results of which form the basis for making judgments about the carrying values of assets and liabilities that are not readily apparent from other sources. Actual results may differ under different assumptions or conditions.

Our accounting policies that involve the most significant judgments and estimates are as follows:

- Revenue recognition and deferred revenue;
- Allowance for doubtful accounts;
- Long-lived assets;
- Inventory accounting;
- Deferred tax assets; and
- Goodwill.

## [Table of Contents](#)

*Revenue recognition and deferred revenue.* For certain arrangements, such as contracts to perform research and development, prototype development contracts and certain product sales, we record revenues using the percentage of completion method, measured by the relationship of costs incurred to total estimated contract costs. We follow this method since reasonably dependable estimates of the revenue and costs applicable to various stages of a contract can be made. However, the ability to reliably estimate total costs at completion is challenging, especially on long-term prototype development contracts, and could result in future changes in contract estimates. Since many contracts extend over a long period of time, revisions in cost and funding estimates during the progress of work have the effect of adjusting earnings applicable to prior-period performance in the current period. Recognized revenues and profit or loss are subject to revisions as the contract progresses to completion. Revisions in profit or loss estimates are charged to income in the period in which the facts that give rise to the revision become known. Some of our contracts contain incentive provisions, based upon performance in relation to established targets, which are recognized in the contract estimates when deemed realizable.

We recognize revenue from product sales upon customer acceptance, which can occur at the time of delivery, installation, or post-installation, where applicable, provided persuasive evidence of an arrangement exists, delivery has occurred, the sales price is fixed or determinable and the collectibility is reasonably assured. When other significant obligations remain after products are delivered, revenue is recognized only after such obligations are fulfilled. Customer deposits received in advance of revenue recognition are recorded as deferred revenue until customer acceptance is received. Deferred revenue also represents the amount billed to and/or collected from commercial and government customers on contracts which permit billings to occur in advance of contract performance/revenue recognition.

*Allowance for doubtful accounts.* If the financial condition of our customers were to deteriorate, resulting in an impairment of their ability to make payments, additional provisions for bad debt allowances may be required. The allowance for doubtful accounts was \$0 and \$41,000 on September 30, 2004 and March 31, 2004, respectively.

*Long-lived assets.* We periodically evaluate our long-lived assets for potential impairment under Statement of Financial Accounting Standards (SFAS) No. 144, "Accounting for the Impairment or Disposal of Long-Lived Assets." We perform these evaluations whenever events or circumstances suggest that the carrying amount of an asset or group of assets is not recoverable. Our judgments regarding the existence of impairment indicators are based on market and operational performance. Indicators of potential impairment include:

- a significant change in the manner in which an asset is used;
- a significant decrease in the market value of an asset;
- a significant adverse change in its business or the industry in which it is sold;
- a current period operating cash flow loss combined with a history of operating or cash flow losses or a projection or forecast that demonstrates continuing losses associated with the asset; and
- significant advances in our technologies that require changes in our manufacturing process.

If we believe an indicator of potential impairment exists, we test to determine whether impairment recognition criteria in SFAS No. 144 have been met. To analyze a potential impairment, we project undiscounted future cash flows over the remaining life of the asset or the primary asset in the asset group, using a probability-weighted multiple scenario approach, reflecting a range of possible outcomes. If these projected cash flows are less than the carrying amount, an impairment loss is recognized based on the fair value of the asset or asset group less any costs of disposition. Evaluating the impairment requires judgment by our management to estimate future operating results and cash flows. If different estimates were used, the amount and timing of asset impairments could be affected. We charge impairments of the long-lived assets to operations if our evaluations indicate that the carrying values of these assets are not recoverable.

## [Table of Contents](#)

No impairment charges were recorded in fiscal 2004 or the first two quarters of fiscal 2005.

*Inventory accounting.* We write down inventory for estimated obsolescence or unmarketable inventory in an amount equal to the difference between the cost of the inventory and the estimated realizable value based upon assumptions of future demand and market conditions. If actual market conditions are less favorable than those projected, additional inventory write-downs may be required. Program costs may be deferred and recorded as inventory on contracts on which costs are incurred in excess of funding, if future funding is deemed probable.

*Deferred tax assets.* We have recorded a full valuation allowance to reduce our deferred tax assets to the amount that is more likely than not to be realized. While we consider future taxable income and tax planning strategies in assessing the need for the valuation allowance, if management were to determine that we would be able to realize deferred tax assets in the future in excess of the net recorded amount, an adjustment to the deferred tax asset would increase income in the period such determination was made. Likewise, should we determine that we would not be able to realize all or part of our net deferred tax assets in the future, an adjustment to the deferred tax asset would decrease income in the period such determination was made.

*Goodwill.* Goodwill represents the excess of cost over net assets of acquired businesses that are consolidated. Pursuant to SFAS No. 142 "Goodwill and Other Intangible Assets," goodwill is not amortized. In lieu of amortization, we perform an impairment review of our goodwill at least annually or when events and changes in circumstances indicate the need for such a detailed impairment analysis, as prescribed by SFAS No. 142. To date, we have determined that goodwill is not impaired, but we could in the future determine that goodwill is impaired, which would result in a charge to earnings.

### Results of Operations

The Company has three reportable business segments—SuperMachines, AMSC Wires, and Power Electronic Systems.

The SuperMachines business segment develops and commercializes electric motors, generators, and synchronous condensers based on HTS wire. Its primary focus for motors and generators is on ship propulsion.

The AMSC Wires business segment develops, manufactures and sells HTS wire. The focus of this segment's current development, manufacturing and sales efforts is on HTS wire for power transmission cables, motors, generators, synchronous condensers and specialty electromagnets.

The Power Electronic Systems business segment develops and sells power electronic converters and designs, manufactures and sells integrated systems based on those converters for power quality and reliability solutions and for wind farm applications.

### Revenues

Total revenues during the three months ended September 30, 2004 were \$9,533,000, a 1% decrease compared to the \$9,614,000 of revenues recorded for the same period a year earlier. For the six months ended September 30, 2004, total revenues were \$22,183,000, a 28% increase over the \$17,371,000 of revenues recorded in the comparable period of the prior year.

Revenues	For the Three Months Ended September 30,		For the Six Months Ended September 30,	
	2004	2003	2004	2003
SuperMachines	\$ 3,553,000	\$ 6,408,000	\$ 10,939,000	\$ 11,958,000
AMSC Wires	3,063,000	2,361,000	6,397,000	3,458,000
Power Electronic Systems	2,917,000	845,000	4,847,000	1,955,000
Total	\$ 9,533,000	\$ 9,614,000	\$ 22,183,000	\$ 17,371,000

## [Table of Contents](#)

The decrease in consolidated revenues of \$81,000 for the quarter ended September 30, 2004 was mainly the result of a \$2,855,000 decline in revenue in the SuperMachines business unit, largely offset by higher revenues in AMSC Wires and Power Electronic Systems.

In the SuperMachines business unit, revenues declined to \$3,553,000 in the quarter ended September 30, 2004 from \$6,408,000 in the same prior-year quarter. Prototype development contract revenues relating to the U.S. Navy 36.5 Megawatt (MW) motor program were constrained by a limitation on funding from the Navy in the quarter ended September 30, 2004. Due to this funding limitation, approximately \$3,100,000 of program costs incurred in excess of available funding were recorded as inventory as of September 30, 2004, because future funding was deemed probable. Incremental funding in excess of the inventoried cost was received from the Navy in mid-October 2004, enabling these inventoried costs to be recognized as revenue in our third fiscal quarter ending December 31, 2004. As work continues to progress on the 36.5 MW motor, the receipt of this incremental funding in October plus additional anticipated funding allotments from the Navy are expected to allow SuperMachines to record substantially higher revenues in the third quarter of fiscal year 2005, compared to the second quarter.

AMSC Wires' revenues increased to \$3,063,000 for the quarter ended September 30, 2004 from \$2,361,000 for the prior-year quarter, an increase of \$702,000 which was driven by \$557,000 in higher HTS wire sales and \$262,000 in higher contract revenues. Wire sales increased to \$1,109,000 in the second quarter of fiscal 2005 from \$552,000 in the same period of the prior year, due to improved manufacturing yields resulting in higher wire shipments, compared to the same prior-year period. Contract revenues increased to \$460,000 from \$198,000, driven by the beginning of work on a second-generation (2G) research contract awarded in June 2004 by the Defense Advanced Research Projects Agency (DARPA). Product sales related to work being performed on the U.S. Department of Energy (DOE) project to install an HTS power cable in the transmission grid of the Long Island Power Authority (LIPA) declined to \$1,494,000 in the second quarter of fiscal 2005 compared to \$1,611,000 in the same quarter of the prior year, as a result of lower subcontractor spending on the program.

Improved sales of D-VAR systems, in particular to wind farm operators, was the primary reason for the \$2,072,000 increase in Power Electronic Systems revenues to \$2,917,000 in the quarter ended September 30, 2004, compared to \$845,000 in the same prior-year quarter.

For the six-month period ended September 30, 2004, total consolidated revenues were \$22,183,000, an increase of \$4,812,000 or 28% compared to \$17,371,000 of revenues for the same period of the prior fiscal year.

SuperMachines revenues decreased by \$1,019,000 to \$10,939,000 in the six-month period ended September 30, 2004 from \$11,958,000 for the same period last year due to the same Navy limitation of funding reasons as noted above. This decline in SuperMachines revenues was more than offset by revenue increases of approximately \$2,900,000 at both AMSC Wires and Power Electronic Systems.

AMSC Wires' revenues increased by \$2,939,000 to \$6,397,000 for the six-month period ended September 30, 2004 from \$3,458,000 for the same prior-year period, due to a \$1,838,000 increase in HTS wire sales and a \$999,000 increase in work performed on the DOE project to install an HTS power cable in the LIPA transmission grid. Wire sales increased to \$2,865,000 in the first six months of fiscal 2005 from \$1,027,000 in the same period last year, due to improved manufacturing yields resulting in higher wire shipments, compared to the same prior-year period. LIPA-related revenues increased to \$2,877,000 for the six-month period ended September 30, 2004 from \$1,878,000 for the same prior-year period, as a result of higher subcontractor spending over the first six months of fiscal 2005, compared to the prior year. Contract revenues increased to \$655,000 from \$553,000 as a result of the beginning of work on the DARPA 2G contract.

Revenues in Power Electronic Systems increased by \$2,892,000 to \$4,847,000 for the six-month period ended September 30, 2004 from \$1,955,000 for the same period of the prior year as a result of a higher level of D-VAR system shipments in the first half of fiscal 2005, primarily to wind farm operators in the United States, Europe, and Canada.

## [Table of Contents](#)

### *Cost-sharing funding*

In addition to reported revenues, we also received funding of \$561,000 for the three months ended September 30, 2004 under three government cost-sharing agreements with the U.S. Air Force, Department of Commerce, and DOE. For the same quarter of the prior year, we recorded approximately \$447,000 of funding from the same three agencies. For the six-month period ended September 30, 2004, we received cost-sharing funding of \$1,067,000, compared to \$759,000 in the same period of the prior year. All of our cost-sharing programs provide funding in support of 2G HTS wire development work being done in the AMSC Wires business unit. We anticipate that a portion of our funding in the future will continue to come from cost-sharing agreements as we continue to develop joint programs with government agencies. As required by government contract accounting guidelines, funding from government cost-sharing agreements is recorded as an offset to R&D and SG&A expenses, rather than as revenues.

### *Costs and expenses*

Total costs and expenses for the quarter ended September 30, 2004 were \$13,768,000, compared to \$15,626,000 for the same period last year. Total costs and expenses for the six-month period ended September 30, 2004 were \$31,404,000, compared to \$31,802,000 for the same period last year.

“Costs of revenue – product sales and prototype development contracts” decreased by \$916,000 to \$9,044,000 for the three months ended September 30, 2004, compared to \$9,960,000 for the same period of the prior year. This decrease was directly related to the lower level of prototype development contract revenues in the SuperMachines business unit and the recording of approximately \$3,100,000 of contract costs as inventory at September 30, 2004, as future funding was deemed probable. This decrease was partially offset by higher costs associated with the increased level of product sales in the AMSC Wires and Power Electronic Systems business units.

“Costs of revenue – product sales and prototype development contracts” increased by \$4,297,000 to \$22,530,000 in the six-month period ended September 30, 2004 from \$18,233,000 for the same period of the prior year in connection with the significantly higher levels of revenue in AMSC Wires and Power Electronic Systems, partially offset by lower costs of revenue in SuperMachines.

“Costs of revenue – contract revenue” increased to \$513,000 and \$697,000 for the three- and six-month periods ended September 30, 2004, respectively, compared to \$186,000 and \$522,000 for the same prior-year periods, in conjunction with the increase in contract revenues.

### *Research and development*

A portion of our R&D expenditures related to externally funded development contracts has been classified as costs of revenue (rather than as R&D expenses). Additionally, a portion of R&D expenses was offset by cost-sharing funding. Our R&D expenditures are summarized as follows:

	Three Months Ended September 30,		Six Months Ended September 30,	
	2004	2003	2004	2003
R&D expenses per Consolidated Statements of Operations	\$ 2,047,000	\$ 3,111,000	\$ 3,636,000	\$ 7,974,000
R&D expenditures classified as Costs of revenue	5,144,000	6,685,000	13,967,000	11,439,000
R&D expenditures offset by cost-sharing funding	337,000	417,000	658,000	703,000
Pro forma R&D expenses	\$ 7,528,000	\$ 10,213,000	\$ 18,261,000	\$ 20,116,000

R&D expenses (exclusive of amounts classified as costs of revenue and amounts offset by cost-sharing funding) decreased to \$2,047,000 and \$3,636,000 in the three and six months ended September 30, 2004,



## [Table of Contents](#)

respectively, from \$3,111,000 and \$7,974,000 for the same periods last year primarily as a result of two factors: a higher percentage of the R&D costs was classified as costs of revenue or into inventory in connection with the prototype development contract work in SuperMachines and a higher percentage of AMSC Wires' labor and overhead costs was absorbed into costs of revenue in support of the higher level of product sales. Pro forma R&D expenses, which include amounts classified as costs of revenue and amounts offset by cost-sharing funding, decreased to \$7,528,000 and \$18,261,000 in the three and six months ended September 30, 2004, respectively, from \$10,213,000 and \$20,116,000 for the same periods last year, as a result of the recording of certain 36.5 MW motor program-related costs as inventory in the SuperMachines business unit. Other increases in spending, such as the higher subcontractor costs associated with the LIPA program over the first six months of fiscal 2005 compared to the same prior-year period, were offset by cost savings associated with headcount and controllable expense reductions which began in July 2003.

### *Selling, general, and administrative*

A portion of the SG&A expenditures related to externally funded development contracts has been classified as costs of revenue (rather than as SG&A expenses). Additionally, a portion of SG&A expenses was offset by cost-sharing funding. Our SG&A expenditures are summarized as follows:

	Three Months Ended September 30,		Six Months Ended September 30,	
	2004	2003	2004	2003
SG&A expenses per Consolidated Statements of Operations	\$ 2,164,000	\$ 2,368,000	\$ 4,541,000	\$ 5,072,000
SG&A expenditures classified as Costs of revenue	1,062,000	1,602,000	3,064,000	3,127,000
SG&A expenditures offset by cost-sharing funding	225,000	30,000	409,000	57,000
Pro forma SG&A expenses	\$ 3,451,000	\$ 4,000,000	\$ 8,014,000	\$ 8,256,000

SG&A expenses (exclusive of amounts classified as costs of revenue and amounts offset by cost-sharing funding) decreased to \$2,164,000 and \$4,541,000 in the three and six months ended September 30, 2004, respectively, from \$2,368,000 and \$5,072,000 for the same periods last year primarily as a result of a higher percentage of the SG&A costs being classified as costs of revenue or into inventory in connection with the prototype development contract work in SuperMachines. Pro forma SG&A expenses, which include amounts classified as costs of revenue and amounts offset by cost-sharing funding, decreased to \$3,451,000 and \$8,014,000 for the three and six months ended September 30, 2004 from \$4,000,000 and \$8,256,000 for the same periods last year. Increased SG&A expenses related to higher professional service fees, higher salary and benefit costs, and higher rent associated with our Westborough, Massachusetts corporate headquarters were more than offset by the recording of certain 36.5 MW program-related costs as inventory in the SuperMachines business unit and by cost savings associated with the headcount and controllable expense reductions which began in July 2003. SG&A expenses for the three and six months ended September 30, 2004 included \$135,000 of legal costs related to the lawsuit filed against us on November 5, 2003 by TM Capital, and our counterclaims against TM Capital, compared to \$0 for the same prior-year periods.

We present pro forma R&D and pro forma SG&A expenses, which are non-GAAP measures, because we believe this presentation provides useful information on our aggregate R&D and SG&A spending.

### *Non-operating expenses/Interest income*

Interest income increased to \$160,000 and \$304,000 in the three and six months ended September 30, 2004, respectively, from \$48,000 and \$82,000 for the same periods of the prior year. This increase in interest income reflects the higher cash balance available for investment as a result of our October 2003 public offering of 5,721,250 shares of our common stock that generated net proceeds (after deducting underwriting discounts and commissions, but before deducting offering expenses) of \$51,148,000.

## [Table of Contents](#)

Fees—abandoned debt financing of \$0 and \$35,000 for the three and six months ended September 30, 2004, respectively, compared to \$1,356,000 for the three- and six-month periods ended September 30, 2003, represented various legal fees and expenses incurred in connection with a debt financing transaction that we decided not to pursue in August 2003 in favor of a public equity offering, which we completed in October 2003.

Other income (expense), net was (\$8,000) and (\$77,000) in the three and six months ended September 30, 2004, consisting primarily of losses from the sale of certain pieces of surplus equipment, compared to other income (expense), net of (\$17,000) and \$12,000 in the prior-year quarter and six-month period, respectively.

Based on our latest operating plan, we expect to continue to incur operating losses at least through the fiscal year ending March 31, 2007 as we continue to devote significant financial resources to our commercialization efforts and to our ongoing research and development activities.

### ***Fiscal Years Ended March 31, 2004 and March 31, 2003***

#### *Revenues*

Total consolidated revenues increased to \$41,309,000 in fiscal 2004 from \$21,020,000 in fiscal 2003, an increase of \$20,289,000 or 97%.

Revenues	Fiscal Year Ended March 31,	
	2004	2003
SuperMachines	\$ 26,501,000	\$ 6,125,000
AMSC Wires	7,796,000	3,961,000
Power Electronic Systems	7,012,000	10,934,000
<b>Total</b>	<b>\$ 41,309,000</b>	<b>\$ 21,020,000</b>

Our SuperMachines business unit recognized revenues of \$26,501,000 in fiscal 2004, an increase of \$20,376,000 or 333% over fiscal 2003 revenues of \$6,125,000. This was primarily the result of higher prototype development contract revenues associated with work performed on the 36.5 Megawatt (MW) HTS motor contract with the U.S. Navy, which was awarded in March 2003 at an estimated contract value of \$70,000,000 (including potential incentives). Over 93% of this business unit's fiscal 2004 revenues, or \$24,724,000, related to work performed on the 36.5 MW program. Backlog on the 36.5 MW contract as of March 31, 2004 was in excess of \$40,000,000, which we expect to recognize as revenue over our next two fiscal years ending March 31, 2006. As of March 31, 2004, U.S. Navy funding of \$30,948,000 had been allotted to the 36.5 MW contract, which we expect will continue to be funded on an incremental basis.

The remainder of SuperMachines' revenues for the fiscal year ended March 31, 2004 related to the completion of work on the 5 MW motor, which was delivered to the U.S. Navy in July 2003, progress made on the SuperVAR™ synchronous condenser prototype being built for the Tennessee Valley Authority (TVA), and the commencement of work in the second half of fiscal 2004 on two other U.S. Navy programs to analyze HTS propulsion system benefits and to provide test support to the 5 MW motor. In the prior fiscal year ended March 31, 2003, revenues of \$6,125,000 consisted predominantly of work performed on the 5 MW motor program (\$4,914,000) and the beginning of work on the 36.5 MW program (\$1,185,000) in March 2003.

Revenues in our AMSC Wires business unit were \$7,796,000 in fiscal 2004 compared to \$3,961,000 in fiscal 2003, an increase of \$3,835,000 or 97% caused primarily by the beginning of work on the project to install an HTS power cable in the transmission grid of the Long Island Power Authority (LIPA). Revenues associated with the LIPA project, which began in April 2003 and is funded by the U.S. Department of Energy, were \$3,628,000 in fiscal 2004. We expect our AMSC Wires business unit to record a total of approximately \$15,200,000 in revenue (of which approximately \$10,700,000 relates to subcontracts) from this project during the period April 2003 through approximately April 2006. Backlog on the LIPA project as of March 31, 2004 was approximately \$11,600,000.

## [Table of Contents](#)

The remaining \$207,000 increase in AMSC Wires' revenues resulted from higher HTS wire sales, which increased by \$1,030,000 in fiscal 2004 to \$2,636,000 from \$1,606,000 in fiscal 2003, offset by a decrease of \$225,000 in HTS current lead sales and a decrease of \$758,000 in revenue recognized on the Dupont coil program, which we completed in fiscal 2004. Contract revenues in the AMSC Wires business unit also increased by \$160,000 in fiscal 2004 to \$875,000 from \$715,000 in fiscal 2003, due primarily to a higher level of work performed on several U.S. government-sponsored programs focused on 2G HTS wire development.

Power Electronic Systems business unit sales, which include D-VAR<sup>®</sup> and PQ-IVR<sup>™</sup> integrated power electronic systems and power electronic converters, were \$7,012,000 in fiscal 2004 compared to \$10,934,000 in fiscal 2003, a decrease of \$3,922,000. Fiscal 2004 revenues decreased in this business unit as a result of fewer D-VAR system sales in fiscal 2004, compared to fiscal 2003, and a \$1,583,000 reduction in prototype development contract revenues associated with our Power Electronic Building Blocks (PEBB) program with the U.S. Navy, which we substantially completed in fiscal 2004.

Included in the third quarter of fiscal 2004 was \$3,250,000 of revenues and \$3,250,000 of costs of revenue relating to the sale of six D-SMES units to ATC. These six D-SMES units were originally delivered in fiscal 2001 to another one of our customers, WPS, for a total purchase price of \$3,787,000. As the sale of these units to WPS was originally subject to certain return and buyback provisions that expired from 2002 to 2009, we deferred recognition of the revenue related to the original sale until the applicable buyback provisions lapsed. The buyback provisions, which were subject to a minimum 6-month written notice requirement, began to lapse in the quarter ended December 31, 2002, until which time WPS had the right to return all the units for the full purchase price of \$3,787,000. We recorded \$537,000 of revenue and an equal amount of cost of revenue in the quarter ended December 31, 2002, as the buyback price was reduced from \$3,787,000 to \$3,250,000. In December 2003, WPS exercised its buyback provision for the remaining \$3,250,000 price as part of an agreement whereby ATC unconditionally purchased the six D-SMES units. ATC's purchase of the D-SMES units was a follow-up to its purchase of substantially all of the transmission assets of WPS in January 2001 and a lengthy performance evaluation of the units. As a result, we recorded \$3,250,000 of revenue and an equal amount of cost of revenue on our consolidated statement of operations for the quarter ended December 31, 2003.

### *Cost-sharing funding*

In addition to reported revenues, we also received funding of \$2,395,000 in fiscal 2004 under four U.S. government cost-sharing agreements, compared to \$764,000 in fiscal 2003 under two such cost-share programs, an increase of \$1,631,000 or 213%. Two of the fiscal 2004 programs were funded by the Air Force, the other two by the Department of Commerce and the Department of Energy; all four programs provided funding in support of 2G HTS wire development work being done in the AMSC Wires business unit. Three of the four programs will remain active in fiscal 2005 ending March 31, 2005; the fourth cost-sharing program completed in the fourth quarter of fiscal 2004. As required by government contract accounting guidelines, funding from government cost-sharing agreements is recorded as an offset to research and development and selling, general and administrative expenses, rather than as revenue.

### *Costs and expenses*

Total costs and expenses for the year ended March 31, 2004 were \$66,995,000 compared to \$109,532,000 for the prior year, a decrease of \$42,537,000. Fiscal 2003 costs and expenses included \$45,276,000 of non-cash charges recorded in the fourth quarter related to an asset impairment (\$39,231,000), an inventory write-down (\$3,421,000) and an increase in the allowance for doubtful accounts (\$2,624,000). Costs and expenses exclusive of impairment and other charges, which is a non-GAAP measure, were \$64,256,000 in fiscal 2003. Fiscal 2004 costs and expenses of \$66,995,000 were higher than the fiscal 2003 costs and expenses, excluding the impairment and other charges, of \$64,256,000 due primarily to higher material and subcontractor costs associated with the Navy 36.5 MW and LIPA programs, partially offset by cost reductions implemented by us in July 2003, including a reduction in force of 23 employees, or 8% of our workforce at the time. We present costs and expenses exclusive of impairment and other charges because we believe this presentation provides investors with a useful view of our operating results by isolating certain charges and describing our performance without them.

## [Table of Contents](#)

“Costs of revenue—product sales and prototype development contracts” increased by \$11,937,000 to \$43,455,000 in fiscal 2004 from \$31,518,000 in fiscal 2003 due to costs incurred in support of significantly higher fiscal 2004 product sales and prototype development contract revenues in the SuperMachines and AMSC Wires business units, partially offset by lower costs of revenue associated with the lower level of product sales in the Power Electronic Systems business unit. “Costs of revenue—contract revenue” increased proportionally with the higher level of contract revenue.

### *Research and development*

A portion of our research and development (R&D) expenditures related to externally funded development contracts has been classified as costs of revenue (rather than as R&D expenses). Additionally, a portion of R&D expenses was offset by cost sharing funding. Our R&D expenditures are summarized as follows:

	Fiscal Year Ended March 31,	
	2004	2003
R&D expenses per Consolidated Statements of Operations	\$ 14,056,000	\$ 21,940,000
R&D expenditures classified as Costs of revenue	25,442,000	10,997,000
R&D expenditures offset by cost sharing funding	1,852,000	510,000
Pro forma R&D expenses	\$ 41,350,000	\$ 33,447,000

R&D expenses (exclusive of amounts classified as costs of revenue and amounts offset by cost sharing funding) decreased by \$7,884,000 to \$14,056,000 in fiscal 2004 from \$21,940,000 in fiscal 2003 primarily as a result of a higher percentage of the R&D costs being classified as costs of revenue due to the higher level of funded prototype development contract work in the SuperMachines business unit. Pro forma R&D expenses, which include amounts classified as costs of revenue and amounts offset by cost sharing funding, increased by \$7,903,000 to \$41,350,000 in fiscal 2004 from \$33,447,000 in fiscal 2003 as a result of a \$7,988,000 increase in spending in SuperMachines, most of which was material, subcontractor, and temporary labor costs related to the 36.5 MW program. Other increases in spending, such as the additional subcontractor costs associated with the LIPA program, were offset by reductions in R&D spending in AMSC Wires and Power Electronic Systems and cost savings associated with the headcount and controllable expense reductions implemented in July 2003.

### *Selling, general, and administrative*

A portion of our selling, general, and administrative (SG&A) expenditures related to externally funded development contracts has been classified as costs of revenue (rather than as SG&A expenses). Additionally, a portion of SG&A expenses was offset by cost sharing funding. Our SG&A expenditures are summarized as follows:

	Fiscal Year Ended March 31,	
	2004	2003
SG&A expenses per Consolidated Statements of Operations	\$ 8,659,000	\$ 16,159,000
SG&A expenditures classified as Costs of revenue	7,395,000	1,482,000
SG&A expenditures offset by cost sharing funding	543,000	255,000
Pro forma SG&A expenses	\$ 16,597,000	\$ 17,896,000

SG&A expenses (exclusive of amounts classified as costs of revenue and amounts offset by cost sharing funding) decreased by \$7,500,000 to \$8,659,000 in fiscal 2004 from \$16,159,000 in fiscal 2003 primarily as a result of a higher percentage of the SG&A costs being classified as costs of revenue due to the higher level of funded prototype development contract work in the SuperMachines business unit. Pro forma SG&A expenses, which include amounts classified as costs of revenue and amounts offset by cost sharing funding, decreased by

## [Table of Contents](#)

\$1,299,000 to \$16,597,000 in fiscal 2004 from \$17,896,000 in fiscal 2003, which included \$2,624,000 relating to an increase in the allowance for doubtful accounts for a Power Electronics System receivable. SG&A expenses increased in certain areas in fiscal 2004 compared to fiscal 2003, related mainly to higher legal and other professional service fees, as well as a higher percentage of the rent and occupancy costs associated with our Westborough, Massachusetts corporate headquarters now being classified as SG&A expense rather than in costs of revenue and research and development expense, as they were in fiscal 2003. We have completed the relocation of our manufacturing workforce to Devens, Massachusetts from Westborough, which is now partially unoccupied. These increases in SG&A expenses were more than offset by a decrease in the allowance for doubtful accounts and the headcount and controllable expense reductions implemented in July 2003.

We present pro forma R&D and pro forma SG&A expenses, which are non-GAAP measures, because we believe this presentation provides useful information on our aggregate R&D and SG&A spending.

### *Impairment*

An impairment charge was recorded in fiscal 2003 of \$39,231,000 primarily on our building and equipment assets in Devens, Massachusetts, in connection with our plans to transition over the next several years to a lower cost, 2G HTS wire manufacturing methodology.

### *Non-operating expenses/Interest income*

Interest income decreased to \$296,000 in fiscal 2004 from \$869,000 in fiscal 2003. This decrease in interest income reflects the lower interest rates available on our investments and lower average cash balances available for investment over the course of fiscal 2004, compared to fiscal 2003, as a result of cash being used to fund our operations and to purchase property, plant and equipment. However, interest income and cash balances available for investment increased in the second half of fiscal 2004, compared to the first half of fiscal 2004, as a result of our October 2003 public equity offering of 5,721,250 shares of our common stock that generated net proceeds (after deducting underwriting discounts and commissions, but before deducting offering expenses) of \$51,148,000.

Fees—abandoned debt financing of \$1,388,000 in fiscal 2004 represented various fees and expenses incurred in connection with our previously announced debt financing transaction that we decided not to pursue in August 2003 in favor of a public equity offering, which we completed in October 2003.

Other income (expense), net was \$45,000 in fiscal 2004, compared to \$10,000 in fiscal 2003, consisting primarily of income from gains on the sale of excess equipment.

## ***Fiscal Years Ended March 31, 2003 and March 31, 2002***

### *Revenues*

Total consolidated revenues increased to \$21,020,000 in fiscal 2003 from \$11,650,000 in fiscal 2002, an increase of \$9,370,000 or 80%.

<u>Revenues</u>	<u>Fiscal Year Ended March 31,</u>	
	<u>2003</u>	<u>2002</u>
Power Electronic Systems	\$ 10,934,000	\$ 1,416,000
SuperMachines	6,125,000	5,840,000
AMSC Wires	3,961,000	4,394,000
<b>Total</b>	<b>\$ 21,020,000</b>	<b>\$ 11,650,000</b>

Power Electronic Systems business unit sales, which include D-VAR integrated power electronic systems and power electronic converters, were \$10,934,000 in fiscal 2003 compared to \$1,416,000 in fiscal 2002, an increase of \$9,518,000. Power Electronic Systems sales for fiscal 2003 included multiple D-VAR system sales to

## [Table of Contents](#)

Northeast Utilities and Rayburn Electric, and additional system sales to BC Hydro and PacifiCorp, compared to one D-VAR sale in fiscal 2002 to TVA. In addition, the Power Electronics Systems business unit recognized \$2,121,000 of prototype development contract revenues in connection with work performed on our U.S. Navy contract on PEBB in fiscal 2003, compared to \$197,000 in fiscal 2002.

Our SuperMachines business unit recognized revenues of \$6,125,000 in fiscal 2003, an increase of \$285,000 or 5% over fiscal 2002 revenues of \$5,840,000. This was the result of higher prototype development contract revenues associated with fiscal 2003 work performed on the 5 MW and 36.5 MW HTS motor contracts with the U.S. Navy, the second of which was awarded in March 2003. On March 3, 2003, we announced the receipt of a three-year \$70 million contract from the U.S. Navy for the delivery of a 36.5 MW HTS propulsion motor for future electric-powered warships. In the first month of work on this incrementally funded contract, we recognized revenues of \$1,185,000 on the 36.5 MW motor program.

Revenues in our AMSC Wires business unit were \$3,961,000 in fiscal 2003 compared to \$4,394,000 in fiscal 2002, a decrease of \$433,000 or 10% caused primarily by a \$1,396,000 reduction in contract revenues, partially offset by a \$963,000 increase in product sales in fiscal 2003. Pirelli Energy Cables and System provided us with \$1,500,000 of research and development funding in fiscal 2002, but no funding in fiscal 2003, causing the decline in contract revenues. This discontinuance of Pirelli funding in fiscal 2003 was the result of a license agreement signed with Pirelli in February 2002 which allows us to sell our HTS wire to other cable manufacturers in addition to Pirelli. AMSC Wires' product sales were \$3,246,000 in fiscal 2003, compared to \$2,283,000 in fiscal 2002. The \$963,000 increase in AMSC Wires' product sales in fiscal 2003 was driven by higher sales of HTS wire in the fourth quarter of fiscal 2003.

### *Cost-sharing funding*

In addition to reported revenues, we also received funding of \$764,000 in fiscal 2003 under two government cost-sharing agreements, compared to \$603,000 in fiscal 2002. As required by government contract accounting guidelines, funding from government cost-sharing agreements is recorded as an offset to Research and development and Selling, general and administrative expenses, rather than as revenue. We anticipate that a portion of our funding in the future will continue to come from cost-sharing agreements as we continue to develop joint programs with government agencies.

### *Costs and expenses*

Total costs and expenses for the year ended March 31, 2003 were \$109,532,000 compared to \$73,203,000 for the prior year, an increase of \$36,329,000. These costs and expenses included \$45,276,000 of non-cash charges recorded in the fourth quarter of fiscal 2003 related to an asset impairment, an inventory write-down and an increase in the allowance for doubtful accounts. Fiscal 2002 costs and expenses included \$13,867,000 of charges related to the restructuring and product line consolidation implemented in March 2002 and to the purchase of a license from Pirelli in February 2002. Costs and expenses exclusive of impairment and other charges, which are non-GAAP measures, were \$64,256,000 in fiscal 2003 and \$59,336,000 in fiscal 2002. This increase of \$4,920,000 was primarily due to materials and other outside costs associated with the higher level of fiscal 2003 revenues. We present costs and expenses exclusive of impairment and other charges because we believe this presentation provides investors with a useful view of our operating results by isolating certain charges and describing our performance without them.

“Costs of revenue—product sales and prototype development contracts” increased by \$14,219,000 to \$31,518,000 in fiscal 2003, compared to \$17,299,000 in fiscal 2002, due to higher fiscal 2003 revenues, particularly in the Power Electronic Systems business unit, and the costs related to the AMSC Wires business unit's occupancy of the Devens, Massachusetts manufacturing plant. “Costs of revenue—product sales and prototype development contracts” in Power Electronics Systems increased by \$6,121,000 due to higher systems shipments. Devens-related costs (including building and equipment depreciation) increased by \$6,428,000 in fiscal

## [Table of Contents](#)

2003 compared to fiscal 2002, when Devens costs were just beginning to be incurred. “Costs of revenue—product sales and prototype development contracts” also increased due to the higher level of product sales in the AMSC Wires business unit and the higher level of prototype development contract revenues in SuperMachines. “Costs of revenue—contract revenue” decreased proportionally with the lower level of contract revenue.

### *Research and development*

Pro forma R&D expenses, which include amounts classified as costs of revenue and amounts offset by cost sharing funding, decreased by \$3,435,000 to \$33,447,000 in fiscal 2003, compared to \$36,882,000 in fiscal 2002. This decrease was primarily the result of reduced R&D spending in the AMSC Wires and Power Electronic Systems business units of \$3,096,000 and \$2,315,000, respectively, related to the reduction in force implemented as part of our March 2002 restructuring, and additional headcount reductions taken in January 2003. These decreases in R&D spending were partially offset by higher R&D spending, both internally and externally funded, in the SuperMachines business unit of \$1,976,000. A portion of the R&D expenditures related to externally funded development contracts has been classified as costs of revenue (rather than as R&D expenses). Additionally, a portion of R&D expenses was offset by cost sharing funding. Net R&D expenses (exclusive of amounts classified as costs of revenues and amounts offset by cost sharing funding) decreased to \$21,940,000 in fiscal 2003 from \$27,814,000 in fiscal 2002.

Our R&D expenditures are summarized as follows:

	Fiscal Year Ended March 31,	
	2003	2002
R&D expenses per Consolidated Statements of Operations	\$ 21,940,000	\$ 27,814,000
R&D expenditures on development contracts classified as Costs of revenue	10,997,000	8,757,000
R&D expenditures offset by cost sharing funding	510,000	311,000
Pro forma R&D expenses	\$ 33,447,000	\$ 36,882,000

### *Selling, general and administrative*

Pro forma SG&A expenses, which include amounts classified as costs of revenue and amounts offset by cost sharing funding, decreased by \$368,000 to \$17,896,000 in fiscal 2003, compared to \$18,264,000 in fiscal 2002. This decrease was primarily the result of the reductions in force implemented as part of our March 2002 restructuring, and additional headcount reductions taken in January 2003, partially offset by the \$2,624,000 increase in the allowance for doubtful accounts recorded in March of 2003. A portion of the SG&A expenditures related to externally funded development contracts has been classified as costs of revenue (rather than as SG&A expenses). Additionally, a portion of SG&A expenses was offset by cost sharing funding. Net SG&A expenses (exclusive of amounts classified as costs of revenue and amounts offset by cost sharing funding) was \$16,159,000 in fiscal 2003 compared to \$16,313,000 in the prior year.

Our SG&A expenditures are summarized as follows:

	Fiscal Year Ended March 31,	
	2003	2002
SG&A expenses per Consolidated Statements of Operations	\$ 16,159,000	\$ 16,313,000
SG&A expenditures on development contracts classified as Costs of revenue	1,482,000	1,659,000
SG&A expenditures offset by cost sharing funding	255,000	292,000
Pro forma SG&A expenses	\$ 17,896,000	\$ 18,264,000

We present pro forma R&D and pro forma SG&A expenses, which are non-GAAP measures, because we believe this presentation provides useful information on our aggregate R&D and SG&A spending.

## [Table of Contents](#)

### *Impairment/Restructuring/Pirelli*

An impairment charge was recorded in fiscal 2003 of \$39,231,000 primarily on our building and equipment assets in Devens, Massachusetts, in connection with our plans to transition over the next several years to a lower cost, 2G HTS wire manufacturing methodology.

In fiscal 2002 we recorded \$5,666,000 in restructuring charges and an additional \$4,010,000 charge relating to a Pirelli license cost.

### *Non-operating expenses/Interest income*

Interest income decreased to \$869,000 in fiscal 2003 from \$4,451,000 in fiscal 2002. This decrease in interest income reflects the lower cash balances available for investment as a result of cash being used to fund our operations and to purchase property, plant and equipment, as well as lower interest rates available on our investments. Other income (expense), net was \$10,000 in fiscal 2003, compared to \$117,000 in fiscal 2002, consisting primarily of investment gains from long-term marketable securities.

### **Consolidated Quarterly Results of Operations**

The following table summarizes our quarterly consolidated results of operations for the six quarters ended September 30, 2004. In the opinion of our management, these financial data have been prepared on the same basis as the audited consolidated financial statements and include all adjustments, consisting only of normal recurring adjustments, necessary for a fair presentation of our operating results for such periods. The operating results for any quarter are not necessarily indicative of results to be expected for any future period.

	Three Months Ended					
	June 30, 2003	Sept. 30, 2003	Dec. 31, 2003	March 31, 2004	June 30, 2004	Sept. 30, 2004
	(in thousands, except per share data) (unaudited)					
<b>Statement of Operations Data</b>						
<b>Revenues:</b>						
Contract revenue	\$ 356	\$ 198	\$ 149	\$ 172	\$ 195	\$ 460
Product sales and prototype development contracts	7,400	9,416	12,153	11,464	12,455	9,073
<b>Total revenues</b>	<b>7,756</b>	<b>9,614</b>	<b>12,302</b>	<b>11,636</b>	<b>12,650</b>	<b>9,533</b>
<b>Costs and expenses:</b>						
Costs of revenue – contract revenue	335	186	142	161	184	513
Cost of revenue – product sales and prototype development contracts	8,273	9,960	13,577	11,645	13,486	9,044
Research and development	4,863	3,111	3,611	2,470	1,589	2,047
Selling, general and administrative	2,705	2,368	1,578	2,009	2,377	2,164
<b>Total costs and expenses</b>	<b>16,176</b>	<b>15,625</b>	<b>18,908</b>	<b>16,285</b>	<b>17,636</b>	<b>13,768</b>
Operating loss	(8,420)	(6,011)	(6,606)	(4,649)	(4,986)	(4,235)
Interest income	35	48	82	132	144	160
Fees – abandoned debt financing	—	(1,356)	(19)	(13)	(35)	—
Other income (expense), net	29	(17)	24	8	(69)	(9)
<b>Net loss</b>	<b>\$ (8,356)</b>	<b>\$ (7,336)</b>	<b>\$ (6,519)</b>	<b>\$ (4,522)</b>	<b>\$ (4,946)</b>	<b>\$ (4,084)</b>
<b>Net loss per common shares (basic and diluted)</b>	<b>\$ (0.39)</b>	<b>\$ (0.34)</b>	<b>\$ (0.25)</b>	<b>\$ (0.16)</b>	<b>\$ (0.18)</b>	<b>\$ (0.15)</b>
<b>Weighted average number of common shares outstanding (basic and diluted)</b>	<b>21,344</b>	<b>21,382</b>	<b>26,575</b>	<b>27,489</b>	<b>27,724</b>	<b>27,760</b>



## Liquidity and Capital Resources

At September 30, 2004, we had cash, cash equivalents and marketable securities of \$45,655,000 compared to \$52,647,000 at March 31, 2004, a decrease of \$6,992,000 over the first half of the fiscal year. The principal uses of cash for the six months ended September 30, 2004 were \$6,020,000 for the funding of our operations, including significant increases in working capital needs due to the build-up of inventory in SuperMachines and Power Electronic Systems in anticipation of higher projected revenues in the third quarter of fiscal 2005, and \$891,000 for the acquisition of equipment, primarily for our 2G HTS wire process. An increase in other assets of \$1,272,000, primarily as a result of a capitalized license payment made in the first quarter ended June 30, 2004, was offset by proceeds from the issuance of common stock of \$1,205,000, derived primarily from the exercise of stock options.

We have generated operating losses since our inception in 1987 and expect to continue incurring losses until at least the end of fiscal 2007. Operating losses for the fiscal years ended March 31, 2004, 2003 and 2002 contributed to net cash used by operating activities of \$17,422,000, \$39,605,000 and \$26,456,000, respectively, for these periods. For the six months ended September 30, 2004, net cash used by operating activities was \$6,020,000.

In October 2003, we completed a public equity offering of 5,721,250 shares of our common stock that generated net proceeds (after deducting underwriting discounts and commissions, but before deducting offering expenses) of \$51,148,000, in order to supplement our anticipated cash needs for operations as well as our investment in the 2G HTS wire development program. Although our cash requirements fluctuate based on a variety of factors, including customer adoption of our products and our research and development efforts to commercialize our products, we believe that our available cash, together with the proceeds of this offering, will be sufficient to fund our working capital, capital expenditures, and other cash requirements for at least the next three years.

We have potential funding commitments (excluding amounts included in accounts receivable) of approximately \$57,116,000 to be received after September 30, 2004 from government and commercial customers, compared to \$65,301,000 at March 31, 2004. However, these current funding commitments, including \$42,279,000 on U.S. government contracts, are subject to certain standard cancellation provisions. Additionally, several of our government contracts are being funded incrementally, and as such, are subject to the future authorization and appropriation of government funding on an annual basis. We have a history of successful performance under incrementally-funded contracts with the government.

Included in our current potential funding commitment amount is \$30,946,000 relating to the Navy 36.5 MW motor contract, which represents the total base program value (excluding certain potential performance-based incentive fees) of \$66,611,000, plus \$317,000 of approved incentive fees, less the \$35,982,000 of revenue recognized for the program through September 30, 2004.

Of the current commitment amount of \$57,116,000 as of September 30, 2004, approximately 76% is billable to and potentially collectable from our customers within the next 12 months.

The possibility exists that we may pursue acquisition and joint venture opportunities in the future that may affect liquidity and capital resource requirements.

To date, inflation and foreign exchange have not had a material impact on our financial results.

**New Accounting Pronouncements**

In March 2004, the Emerging Issues Task Force (EITF) reached a consensus on EITF No. 03-01, “The Meaning of Other-Than Temporary Impairment and its Application to Certain Investments.” EITF No. 03-01 addresses disclosures about unrealized losses on available-for-sale debt and equity securities and the evaluation of other-than temporary impairment related to securities accounted for under FASB Statement No. 115, “Accounting for Certain Investments in Debt and Equity Securities.” The provisions of EITF No. 03-01 are effective for other-than temporary impairment and disclosures in fiscal periods beginning after June 15, 2004. The adoption of EITF No. 03-01 had no impact on our financial position or operating results.

On December 16, 2004 the Financial Accounting Standards Board (FASB) issued its final standard on accounting for share-based payments, FASB Statement No. 123R (revised 2004), Share-Based Payment (FAS 123R), that requires companies to expense the value of employee stock options and similar awards. FAS 123R addresses the accounting for share based payment transactions with employees, excluding employee stock ownership plans (ESOPs) and awards made in connection with business combinations. Examples include employee stock purchase plans (ESPPs), stock options, restricted stock, and stock appreciation rights. Under FAS 123R, the most significant change in practice would be treating the fair value of stock based payment awards that are within its scope as compensation expense in the income statement beginning on the date that a company grants the awards to employees. The expense would be recognized over the vesting period for each option tranche and adjusted for actual forfeitures that occur before vesting. This pronouncement is effective beginning in fiscal periods beginning after June 15, 2005. We are currently assessing the impact the adoption of this standard will have on our financial position and results from operations.

## BUSINESS

### Overview

We are a leading electricity solutions company. We develop and manufacture products to dramatically improve the cost, efficiency and reliability of systems that generate, deliver and use electric power. Our products include high temperature superconductor (HTS) wire for electric power, transportation, medical and industrial processing applications; motors and generators based on our HTS wire for ship propulsion and industrial uses, as well as synchronous condensers for transmission and distribution grid reliability; and advanced power electronic systems that ensure the quality and reliability of electricity for residential, commercial and industrial end users.

Our HTS wire carries direct current (DC) without any loss of electrical power, resulting in high electrical efficiency. Our HTS wire also conducts more than 140 times the electrical current of copper wire of the same dimensions, which dramatically reduces the size and weight of electrical equipment made with our HTS wire and significantly increases the power throughput of power cables. Our current and planned products are sold or planned to be sold to electric utilities and transmission and distribution grid operators, electrical equipment manufacturers, industrial power users and shipbuilders that utilize electric motors for ship propulsion systems. Our technology and products are backed by an intellectual property portfolio that as of December 31, 2004 includes more than 390 patents and patent applications owned by us worldwide and more than 375 patents and patent applications licensed from others worldwide.

Our products, and those sold by others who incorporate our products, can:

- increase the reliability, security and power transfer capacity of electricity transmission and distribution power grids;
- improve the quality of electric power delivered to manufacturing plants;
- meet the grid interconnection standards required by wind farms and other sources of renewable energy;
- reduce the manufacturing and operating costs of primary electrical equipment, including motors and generators;
- reduce the size and weight of power cables, motors, generators, and other electric power equipment; and
- conserve energy resources used to produce electricity, such as oil, gas and coal, by more efficiently conducting and converting electricity into useful forms.

We believe there will be significant market demand for our products because of the following factors:

- demand for electric power continues to grow on a global basis;
- the power grids in the U.S. and in many developed nations face severe constraints in adequately and safely delivering the amounts of power demanded by electric power users;
- power reliability and power quality are increasingly important as economies transition to computerized and digitized systems;
- U.S. domestic policy is now addressing the need to upgrade the transmission and distribution power grid as part of an effective long-term national energy policy; and
- environmental threats from global industrialization and population growth continue to influence nations to encourage environmentally friendly power technologies.

We conduct our operations through three business units:

- AMSC Wires, a developer and manufacturer of HTS wire;
- SuperMachines, a designer and manufacturer of rotating machines based on our HTS wire, including electric motors, generators and synchronous condensers; and
- Power Electronic Systems, a designer and manufacturer of power electronic converters and integrated power electronic systems that increase power grid reliability and throughput and ensure high quality power for industrial manufacturing operations.

## Superconductor Technology

A superconductor is a perfect conductor of electricity. It carries DC with 100 percent efficiency because no energy is dissipated by resistive heating. DC in a superconducting loop can flow undiminished forever. Superconductors can also conduct alternating current (AC) but with some slight loss of energy.

Superconductor materials lose all resistance to the flow of DC and nearly all resistance to the flow of AC when they are cooled below a critical temperature. The critical temperature is different for each superconductor material. Superconductor materials, including both HTS materials and low temperature superconductor (LTS) materials, need to be cooled to very low temperatures to act as superconductors. Wires made with HTS material typically operate at temperatures that are five to 20 times higher than the operating temperatures of LTS materials. The process of cooling LTS materials to their critical temperature is expensive and often difficult, which limits the commercial applications of LTS technology. Conversely, the lower cost of cooling HTS materials broadens the range of potential commercial superconductor applications.

A combination of three conditions must be met for a material to exhibit superconductor behavior:

- The material must be cooled below its critical temperature ( $T_c$ );
- The current passing through a cross-section of the material must be below a level known as the critical current density ( $J_c$ ); and
- The magnetic field to which the material is exposed must be below a value known as the critical magnetic field ( $H_c$ ).

Superconductor materials were initially discovered in 1911. Before 1986, no known superconductor had a critical temperature above 23 Kelvin. Zero Kelvin is the absolute zero of temperature and is the equivalent of minus 459 degrees Fahrenheit; 23 Kelvin is the equivalent of minus 418 degrees Fahrenheit.

In 1986, a breakthrough in superconductivity occurred when two scientists, Dr. K. Alex Muller and Dr. J. Georg Bednorz, at an IBM laboratory in Zurich, Switzerland, identified a ceramic oxide compound, an HTS material, which was shown to be superconductive at 36 Kelvin (minus 395 degrees Fahrenheit). This discovery earned them the Nobel Prize for Physics in 1987, which is one of six Nobel Prizes awarded to date for work on superconductivity. A series of related ceramic oxide compounds that have higher critical temperatures have been subsequently discovered. This family of ceramic superconductors has come to be known as HTS materials. Some of these materials are being actively used throughout the world and by us for practical wire applications. A variety of organic materials have also been discovered, in a class called “fullerenes,” with critical temperatures ranging between those for high temperature ceramic oxide superconductors and low temperature metallic superconductors. Because of the expense and complexity of synthesizing the fullerenes and also their limited performance in a magnetic field, these have generally not been actively considered for wire applications.

In early 2001, it was discovered that a well-known and widely available material, magnesium diboride ( $MgB_2$ ), has a superconductor transition temperature at 40 Kelvin (minus 387 degrees Fahrenheit). The properties of  $MgB_2$  are consistent with those of LTS materials. Because of its potential low cost and ease of synthesis, work was initiated around the world to investigate the use of  $MgB_2$  in wire applications. We initiated a program to investigate the commercial viability of  $MgB_2$  and concluded that it would be very difficult for  $MgB_2$  wire to compete against wires based on HTS materials. We have stopped development activities on  $MgB_2$  but continue to monitor new developments and are poised to reestablish our program if the need arises.

## Power Electronics Technology

Advances in power electronics technology are enabling new, more reliable and efficient use of electric devices and are providing a critical component fundamental to new integrated power solutions that improve the reliability and quality of power delivered to users. Today, our growing digital-based economy demands better power reliability and quality for higher performance through faster power conversion devices and active grid management. Power conversion and active grid management are enabled by power electronic devices, which

## [Table of Contents](#)

convert generated or transmitted electric power to the appropriate form for a particular electrical application. Common examples of power electronic conversion include: AC-DC converters used at the interface between AC power sources and a number of applications that use only DC power; DC-DC converters used to change the DC voltage of a source; and DC-AC converters, commonly called inverters, used to convert DC power to AC power. DC is typically produced by batteries and fuel cells, while AC is typically produced by electric generators and used in homes and businesses.

Power electronic converters incorporate power semiconductor devices that switch, control and move large amounts of power faster and with far less disruption than the electromechanical switches that have historically been used. These power converters can be used in a variety of applications from motor drives, power supplies, voltage regulators, and wind turbines to fuel cells, microturbines and photovoltaics.

Ongoing advances in power electronics technology have spawned new, more reliable and efficient power semiconductor switching devices. We employ devices such as insulated gate bipolar transistors (IGBT) operating in the 300 to 2,000 volt range and at switching frequencies up to 20,000 hertz. We incorporate these into our proprietary, state-of-the-art power electronic converters, which together enable lower cost and more effective, integrated solutions for power reliability and quality. Rather than using discrete packaging, we integrate the IGBTs onto printed circuit boards made of insulating and conductive materials, which increases reliability and reduces manufacturing cost. These circuit boards form a critical building block in our more powerful and smaller power electronic converters. Other key attributes of our power converters are their inherent programmability, flexibility and scalability. Embedded controllers allow end users to customize power converters to meet precise application requirements and optimize the performance characteristics of the device.

## **Market Overview**

### ***Power Demand and Transmission Capacity***

The Electric Power Research Institute (EPRI) has estimated that electricity as a percentage of total energy use in the U.S. was 25 percent in 1970, has recently reached 40 percent, and will increase to 50 percent by 2020. This large projected increase is being driven in part by growth in the use of computers, the Internet, telecommunications, and other consumer-based electronic products. Projected growth rates for electric power consumption by these newer technologies are far higher than for traditional uses of power, which have historically grown in proportion to the gross domestic product of the U.S. We believe this growth in power consumption, and the corresponding demand for more reliable and higher quality power to support digital applications, will create demand for many of our products.

We believe another key factor affecting the market for our products and technologies is the expected need to upgrade the U.S. transmission infrastructure. In May 2002, the U.S. Department of Energy (DOE) issued a National Transmission Grid Study (NTGS), which highlights the important role the power grid plays in our economy, specifically outlines the major bottlenecks in the nation's transmission system and makes recommendations for eliminating them. The report makes clear that if investment in the power grid does not begin now, the power grid will become considerably more congested, resulting in lower reliability and higher prices for electricity. We believe that the recommendations outlined in the NTGS report will be favorable to our efforts to commercialize our products and technologies. The report specifically calls for adopting new technologies including superconductors and power electronics to help alleviate transmission grid congestion and create more secure power networks.

In March 2003, the DOE, in collaboration with the Tennessee Valley Authority (TVA) and the Oak Ridge National Laboratory (ORNL) established the National Transmission Technology Research Center (NTTRC) in Oak Ridge, TN to provide a testing ground for new technologies and products that are designed to meet the needs identified in the NTGS, including those based on HTS materials and power electronics. The DOE, also in March 2003, established a new Office of Electric Transmission and Distribution (OETD), which is tasked with carrying out the recommendations of the NTGS. In April 2003, this office sponsored a National Electric System Vision Meeting in which approximately 60 industry, government and university leaders, including our representatives, gathered to further define the vision for the electric system in the U.S.

## [Table of Contents](#)

In July 2003, based on the input of the vision meeting, the OETD issued a report entitled *Grid 2030—A National Vision for Electricity's Second 100 Years* that reflects the DOE's expectation that HTS and power electronics technologies will play a significant role in upgrading the North American power grid. Also in July 2003, the OETD convened approximately 200 experts to create a technology roadmap to achieve the vision delineated in the Grid 2030 report. The roadmap, entitled *National Electric Delivery Technologies Roadmap*, was published by the DOE in January 2004. This report specifically calls for the rapid development and deployment of HTS and power electronic technologies in order to create more secure power networks in the U.S.

All of these recent actions by the U.S. government indicate the serious nature of the problems affecting the U.S. power grid, the need for significant new investment in the power grid, and the need for HTS technology and advanced power electronics as part of the solution. We believe that we are well positioned to participate in the anticipated increase in investment in the U.S. power grid.

The chart below illustrates the decline in investment in the U.S. power grid over the last several decades. This trend is the result of uncertainties with respect to the ownership of and the return on investment in power grid assets caused by potential changes in power grid regulations and policies. We believe this decrease in investment in the power grid in the U.S., coupled with the increasing demand for more electric power, has contributed to pent-up demand for power grid solutions, which is validated by the recent increases in investments shown in the following chart.

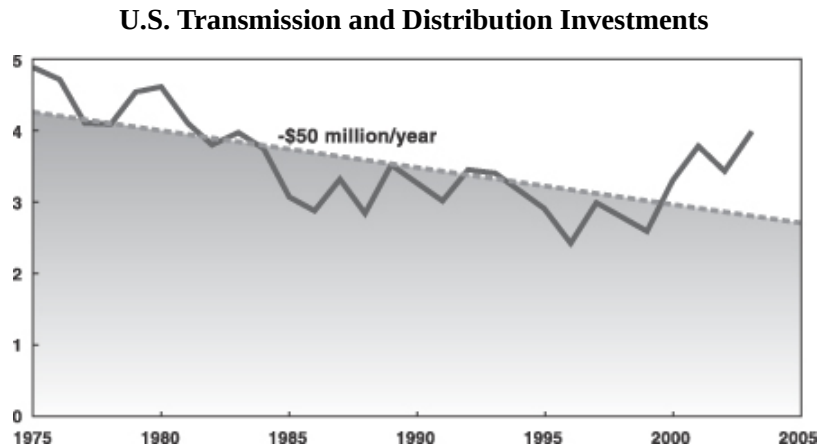

*Eric Hirst, "U.S. Transmission Capacity: Present Status and Future Prospects," June 2004, p. 7. The dotted line, which was obtained by regression analysis shows investment in the U.S. transmission grid decreasing by \$50 million per year during the period of 1975 to 2004. Investment in the U.S. transmission grid started to increase over the last several years.*

We expect that pent-up demand for power grid solutions will be favorable to sales of our current and planned products. In addition, we expect demand for our products and technologies to increase with changes now taking place in certain regulations and policies related to power grid operation and expansion of the power grid.

On August 14, 2003, the largest power outage, or blackout, in U.S. history occurred. It affected approximately 50 million people across the northeastern U.S. and Canada, according to the 2004 Final Blackout Report issued in April 2004 by the U.S.-Canada Power System Outage Task Force, and is estimated to have cost \$6-\$12 billion in lost economic activity. Industry experts had predicted that such blackouts would occur as a result of the increasing demand for electricity and the decreasing rate of investment in the power grid over the last 30 years. We believe that this blackout has created increased public focus on solving power grid problems. We also believe that we are well positioned to address this business growth opportunity.

## [Table of Contents](#)

Since the blackout, U.S. and industry authorities have focused on a range of measures to improve grid reliability. Congress has been unable to come to an agreement on legislative changes to enforce mandatory reliability standards that are backed by fines for non-complying market participants. The Federal Energy Regulatory Commission (FERC) began, within its existing authority, to enact regulatory requirements aimed at improving reliability. The North American Electric Reliability Council (NERC) also issued new guidelines for the industry that require enhanced measures to assure reliability and voltage stability. Although new reliability requirements are fluid and a matter of on-going debate, we believe that these measures will lead to expanded opportunities for our products.

### ***Power Reliability and Power Quality***

The reliability of the power transmission network and the quality of power delivered to customers are becoming increasingly important in today's economy.

Power grid congestion caused by growing electrical demands on capacity-constrained power lines and cables, in addition to voltage instability and low voltage in the power grid, are causing significant reliability problems for the nation's growing digital-based economy.

Downtime due to power-related problems is becoming an increasing concern to many industries as the equipment used to manufacture products utilizes more and more power-sensitive digital components. Protection against power quality problems, such as voltage sags lasting two seconds or less, can provide significant economic value to large industrial users of power. Such momentary sags cause more than 90 percent of all plant shutdowns, which can last from hours to days and be very costly. In the Grid 2030 report, OETD cites industry sources indicating that power outages and power quality disturbances in the U.S. result in economic losses from \$25-\$180 billion annually. The report also states that these losses could significantly increase if future outages or disturbances increase in frequency or duration.

*Power Reliability.* "Power reliability" refers to the ability to deliver power where and when it is needed. Operators of transmission and distribution grids quantify reliability as the fraction of time the power grid is up and running, after subtracting time needed for planned maintenance. Power grid operators are increasingly confronting reliability issues arising from the capacity limitations of transmission and distribution lines (overhead) and cables (underground). Because lines and cables are made with either copper or aluminum wires, they heat up due to the electrical resistance of these metals. Pushing too much power through a line or cable will heat it up to its "thermal limit." At that point, more power flow through the line or cable will cause it to fail. Thus, as demand for power increases in the digital age, it is necessary to upgrade existing transmission and distribution corridors with more or higher capacity lines or cables.

Today, most transmission and distribution lines and cables are run at only 40 to 60 percent of their thermal limits. This is because individual lines and cables reach their "voltage stability limit" well below their thermal limit. Driving more power through a power grid when some of its lines and cables are operating above their voltage stability limit at peak demand times causes either low voltage in the power grid (a "brownout") or risk of a sudden, uncontrollable voltage collapse (a "blackout"). The solution to power reliability problems lies in mitigating dynamic voltage stability problems and in augmenting transmission and distribution grid capacity.

The traditional way to increase power grid capacity and voltage stability is to install more overhead power lines. This allows for redundancy of power flow pathways and allows power grid operators to safely run systems closer to the thermal limits of the weakest links in the power grid. However, as a result of declining investment in the power grids in the U.S. during the last several decades, as well as rising public resistance to new overhead lines due to environmental, aesthetic and health concerns, which can result in permitting processes of five to 10 years or more, few new power lines are being built.

## [Table of Contents](#)

At the local distribution level, the theoretical solution to increasing electricity delivery capacity is to increase the number of copper or aluminum distribution lines and underground cables. However, this approach is not generally practical in large metropolitan areas for two important reasons: (i) many existing underground conduits carrying power distribution cables are already filled to their physical capacity and cannot accommodate any additional cables; and (ii) adding new conduits requires securing new or expanded rights of way and digging up streets to lay new conduit pipe, tasks that are costly and impose significant disruptions.

We offer commercial solutions to these challenges today and are developing innovative solutions for the future. We sell integrated power electronic systems and currently have 36 integrated power electronic systems at 19 customer locations in the U.S., Canada and Europe that provide voltage stabilization in transmission and distribution power grids and clean power for industrial operations. These transmission reliability and industrial power quality systems enable power grids to operate closer to their thermal limits, which in many cases means the existing power grid can carry more power, and increase the productivity and reduce the costs of manufacturing operations that are sensitive to the quality of electric power.

We believe our HTS wire will enable a new class of high capacity, environmentally benign and easy to install transmission and distribution cables that address power grid capacity issues by increasing the thermal limit of existing or new rights of way. We expect that our HTS wire will be utilized in an increasing number of new HTS power cable demonstrations over the next several years. Our HTS dynamic synchronous condensers—AC rotating machines that generate or absorb reactive power to support and stabilize power grid voltage—are designed to increase both the reliability of power grids and the power flow through existing transmission lines. Our first prototype machine is undergoing acceptance testing in a transmission grid operated by TVA, one of the largest public utilities in the U.S. We expect that this prototype product will successfully meet the criteria for acceptance and that TVA, which has ordered the first five commercial HTS dynamic synchronous condensers, will release the orders to production in calendar year 2005. We expect to ship the first commercial HTS dynamic synchronous condenser to TVA in our fiscal year ending March 31, 2006.

**Power Quality.** Distinct from the issue of power reliability is the problem of power quality. Power quality anomalies (most commonly voltage “sags,” which are momentary drops in the voltage in power grids) are an expected part of normal power grid operations, such as re-closure operations used to clear electrical faults in power grids.

The electrical faults may be caused by a variety of factors, including lightning strikes, animals or tree limbs in contact with power lines and even what the industry refers to as “car / pole interactions.” To a residential customer, a momentary power sag may be manifest as nothing more than a briefly flickering kitchen light. To a continuous process manufacturer, that same power quality problem may cause a costly interruption in microprocessor-controlled manufacturing lines. Because momentary sags are part of the normal operation of the power grid, they must be solved at the customer’s site, which we achieve with our power electronics-based industrial power quality solutions.

We believe we are well positioned to participate in the expected increases in investment in power grid reliability solutions and in industrial power quality solutions over the next decade and beyond. We anticipate that our participation in this growing opportunity will be through sales of our existing power electronics-based solutions and in the future, through sales of our HTS dynamic synchronous condensers and our HTS wires for high-capacity power cables. Future transmission applications could also include fault current limiters and transformers.

### ***Power Electronic Converters***

Driven in part by the trend toward a global digital economy, the demand for switching power into useful forms is increasing. This, in conjunction with increasingly economical and efficient power converters, is driving the market for power conversion applications. Industry experts estimate that more than 20 percent of all power



## [Table of Contents](#)

generated in the U.S. passes through power electronic converters at power levels exceeding 60 kilowatts (kW) and that this amount will increase with the introduction of new applications, including distributed and dispersed generation of power.

Electrical devices are becoming more “intelligent” as microprocessors and embedded controllers add new functionality to power converters. Key trends in power electronic converters designed for use in power infrastructure applications include greater modularity and standardization, programmability, and the demand for smaller units with higher power density, which is the amount of power handled per unit volume of the converter device. We are focusing our power converter product development activities on power levels of 60 to 1,000 kW because we believe this is the market segment in which our power conversion technology offers the greatest value to customers.

Based on our market analyses, we believe that the addressable market for our power converter product line, at power levels greater than 60 kW, is over \$700 million per year. The addressable markets include motor drives, uninterruptible power supplies and other power quality systems, wind turbines, electric vehicles, power grid reliability solutions and distributed and dispersed generation devices, such as fuel cells and diesel generators.

### ***Rotating Machines: HTS Motors, Generators and Synchronous Condensers***

We have developed large-scale, HTS rotating AC synchronous machines that can be utilized as electrical motors, generators or dynamic synchronous condensers. To date, we have demonstrated several industrial and marine propulsion motors and a prototype dynamic synchronous condenser based on our HTS rotating AC synchronous machine technology. We plan to develop and commercialize HTS motors, generators and synchronous condensers.

The market for large electric motors and generators is well developed, with strong competitors and intense price pressure. We estimate that the annual worldwide market for industrial motors, which we define as machines with ratings of 1,000 horsepower (hp) or higher, is approximately \$1 billion, and is expanding at a compound annual growth rate (CAGR) of 2 to 4 percent. We estimate that the annual worldwide market for utility-scale electrical generators, which we define as generators with power ratings over 100 mega-volt-amperes (MVA), is approximately \$1.6 billion per year, and the market for industrial generators (typically 20 to 100 MVA) is approximately \$0.4 billion. We estimate that the worldwide market for utility and industrial generators is growing at a CAGR of approximately 2 to 4 percent.

During the last 15 years, the commercial cruise ship industry has made a transition to electric propulsion systems in which electric motors are used to directly drive the ship’s propeller. An electric generator powered by a gas turbine, or other prime mover, provides the electricity to run the motor. The first ship type to convert to a modern electric propulsion system was the cruise ship, with the conversion from steam to electric propulsion of the Queen Elizabeth 2 in 1987. Today, virtually all commercial cruise ships are being built with electric propulsion systems. Similarly, many other types of commercial vessels, including product tankers, Ro-Ro (Roll-on Roll-off) and Ro-Pax (Roll-on Roll-off Passenger), liquefied natural gas carriers, cable layers, research ships and supply craft have been redesigned to incorporate the benefits electric propulsion systems provide over the older mechanical propulsion. The benefits HTS motors and generators provide to the marine propulsion market translate into reduced fuel costs, better ship handling capabilities, increased cargo and passenger cabin space and improved naval ship operational performance.

Naval ship designs around the world are beginning to incorporate electric propulsion as well. In January 2000, the U.S. Navy declared it would transition to electric propulsion systems and is pursuing electric propulsion options for its future ship classes, including destroyers, cruisers, submarines and aircraft carriers.

We estimate that the market for electric motors and generators for ship propulsion systems in 2004 was approximately \$450 million. Industry experts forecast that this market will grow at a CAGR of up to 20 percent over the next 10 years due to the accelerating transition to electric drives, which is already well underway today.

## [Table of Contents](#)

HTS rotating machines, when operated as dynamic synchronous condensers in power grid substations, are capable of generating or absorbing reactive power, which is measured in VARs (volt-amp reactive). In addition to continuous VAR support, an HTS dynamic synchronous condenser, or SuperVAR™ machine, can help stabilize power grids by providing a fast, reliable, low-cost response to transient and disruptive events. This is accomplished through the HTS machine's unique ability to provide multiples of its rated capacity (overload) in response to transient events. SuperVAR machines also produce VARs on a continuous basis to 100 percent of their full rating (both leading and lagging) to increase grid transmission capacity.

Based on our own market analyses and those of TVA, we expect the need for VARs in support of both steady-state and transient power grid operation to continue to rise as the demand for power increases. It is currently estimated that approximately 10,000 mega-VAR (MVAR) of additional support are needed today in the U.S. market, which translates into an annual addressable market of approximately \$200-\$250 million, which we believe will grow at a rate of 4 percent per year. The international market is expected to grow at more than double this rate. We believe HTS dynamic synchronous condensers along with our power electronics solutions such as Dynamic VAR (D-VAR®) can supply a significant fraction of this demand.

Conventional, large electric rotating machine production is labor intensive, requires a large fixed asset investment, and does not lend itself to mass production techniques. As a result, many manufacturers of large motors and generators are seeking opportunities to reduce manufacturing and investment costs to improve profitability. We believe size and weight reductions in large electric motors, generators, and SuperVAR machines resulting from the use of HTS technology will enable significant reductions in manufacturing costs. During the last two years, we have shifted our focus in the development of electric rotating machines to ship propulsion and dynamic synchronous condenser applications. We believe we are well positioned to be a leader in these rapidly growing markets.

### **Our Businesses**

We are organized into three business units: AMSC Wires, SuperMachines and Power Electronic Systems.

Each business unit is run separately by a vice president and general manager, who reports to our president and chief operating officer. Although these business units are run independently, we leverage common customer and technology opportunities across all of the business units. Each of our business units is engaged in the manufacture and sale of commercial or prototype products and in the development of technology and new products. Our Power Electronic Systems business unit has been selling commercial products since 1999. Our AMSC Wires business unit is selling commercial HTS wires that it produces at our full-scale commercial manufacturing plant we opened in December 2002. Our SuperMachines business unit is developing, assembling, and testing prototype motors and synchronous condensers.

A customer set common to all of these business units is power grid operators, and thus, much of our sales and marketing efforts is directed to this customer category. A significant part of our sales and marketing efforts is focused on the U.S.; however, we are currently marketing our products and technologies around the world. Our channels to market include direct sales and distributors such as GE Energy, Kiswire Ltd., and Suzuki Shokan Co., Ltd. In addition, we utilize Northrop Grumman Marine Systems, a division of Northrop Grumman Electronic Systems, for the sale of HTS application products to the U.S. military through an agreement signed in October 2004.

To facilitate our traditional sales and marketing efforts, we have created the Advanced Grid Solutions business development team, comprised of seasoned individuals who have worked in all aspects of power generation, transmission, government regulation and policies, cryogenic systems and cable technology. Also participating in the business development team are four transmission planners with over 70 years of transmission planning experience and a broad depth of knowledge of the design and structure of transmission and distribution

## [Table of Contents](#)

grids. These transmission planning experts use sophisticated software programs to perform power flow and stability analyses on power grids to help determine the best solutions to increase reliability and capacity. The Advanced Grid Solutions business development team is currently working with electric utilities, wind farm operators and industrial users of power to create solutions that utilize our current or planned products.

### **AMSC Wires Business**

The AMSC Wires business unit is responsible for the design, development and manufacture of HTS wires. It sells wire to original equipment manufacturers (OEMs) that incorporate HTS wire into value-added products.

Our commercial wire product is a multi-filamentary composite HTS wire, typically called “first generation” or “1G” HTS wire, which can carry more than 140 times the power of copper wires of the same dimensions. The superconductor compound we utilize in our 1G HTS wire is  $\text{Bi}_{1.8}\text{Pb}_{0.3}\text{Sr}_2\text{Ca}_2\text{Cu}_3\text{O}_{10}$ , commonly referred to as “BSCCO”. Currently, the AMSC Wires business unit is selling 1G HTS wire primarily to OEMs that incorporate the wire into prototype power cables, motors, generators and electromagnet applications for sale to the utility, transportation, ship building and industrial processing markets. Our SuperMachines business unit is an AMSC Wires customer. We also sell wire to customers that are in early stages of research and development. These customers use the wire in products such as power transformers, fault current limiters and electromagnet applications in the medical, materials processing and transportation industries, as well as other fields.

While we have been commercializing 1G HTS wire, we have also been developing “second generation” or “2G” HTS wire that we believe will have better electrical and mechanical performance, and that we will be able to manufacture at a significantly lower cost, than our current 1G HTS wire. The superconductor compound we utilize in our 2G HTS wire is  $\text{YBa}_2\text{Cu}_3\text{O}_7$ , commonly referred to as “YBCO”. We have invested more than \$50 million over a period of eight years to develop our 2G HTS wire technology and during the last year we have made significant advances in the development of our manufacturing processes for 2G HTS wire and the electrical performance of our 2G HTS wire. As a result, we have made a business decision to accelerate the scale-up of manufacturing 2G HTS wire and to transition as rapidly as possible from our current 1G HTS wire to our new 2G HTS wire. We believe our 2G HTS wire will become our main HTS wire product within the next three to four years. However, we can make no assurances that we will be able to complete this transition to 2G HTS wire within this timeframe, or, if we do, that our 2G HTS wire product will be successful in the marketplace.

The graphic below shows the architectures of 1G and 2G HTS wire. Both wires have the same external form and dimensions so 2G HTS wire can easily replace 1G HTS wire in applications that have already adopted 1G HTS wire. The two generations of HTS wire differ in the superconductor materials of which they are comprised, their internal architecture, how they are manufactured, and, in some instances, their end-use applications.

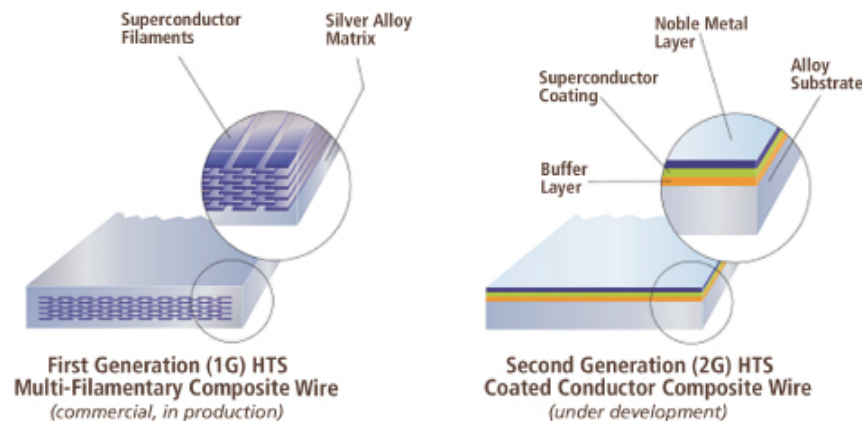

## [Table of Contents](#)

*AMSC Wire Production Techniques.* We produce our commercial 1G HTS wire with deformation processing, which is analogous to the techniques used in the existing metal wire industry. In this approach, a silver alloy tube is packed with an oxide precursor powder and sealed. The tube is then deformed into a wire shape by a variety of deformation processing techniques such as wire-drawing and rolling. Finally, the wire is heat-treated to transform the precursor powder inside the wire into a high temperature superconductor. The resulting composite structure consists of many fine superconductor filaments embedded in a silver matrix. The filaments of HTS material, which are typically one-sixth the thickness of a human hair, extend through the entire length of the wire. The composite structure is the subject of a patent owned by the Massachusetts Institute of Technology (MIT), based on an invention by Dr. Gregory Yurek, our Chairman of the Board, Chief Executive Officer, co-founder, and a former professor at MIT, and co-founder Dr. John Vander Sande, a professor at MIT, and a member of our Board of Directors. This patent is licensed to us on an exclusive basis until its expiration date in 2010.

We have received additional patents based on the 1G HTS wire structure and processes related thereto. As of December 31, 2004, we have over 125 patents and patents pending worldwide related to 1G HTS wire technology, and licenses to over 300 worldwide patents and patents pending owned by others for 1G HTS wire technology. We believe we have a very strong intellectual property position in the area of 1G HTS wire. Currently, we are one of six companies worldwide, and the only one in the Western Hemisphere, manufacturing 1G HTS wire.

In December 2002, we produced our first saleable 1G HTS wire from our state-of-the-art 355,000-square-foot HTS wire manufacturing facility located in Devens, Massachusetts. Operations, engineering and sales for the AMSC Wires business unit are located there as well. Current production capacity is 1,400,000 meters per year. The facility has been designed to expand the production capacity on a “just-in-time” basis as product demand increases.

We produced and shipped 155,000 meters of 1G HTS wire from this facility in its first fiscal year of operation, ended March 31, 2004, and we plan to ship nearly four times that amount – 550,000 meters – in the year ending March 31, 2005. The capacity of our current 1G HTS wire manufacturing operation at this facility can be doubled to 3,000,000 meters per year for approximately \$2 million in additional capital equipment. However, because we have decided to accelerate the transition to 2G HTS wire manufacturing in our Devens plant, it is unlikely we will need to increase the capacity of our 1G manufacturing operation. We believe that approximately 25% of the equipment that we utilize in our 1G HTS wire manufacturing process will be applicable to our 2G HTS wire manufacturing process.

We believe that our 1G HTS wire manufacturing facility will provide us with a competitive advantage as the market for HTS wire continues to grow and as the industry transitions from 1G to 2G HTS wire. Customers from 11 countries around the world are currently utilizing our 1G HTS wire in applications such as power cables, motors, generators and superconductor-based, magnetically levitated (“maglev”) trains. Working with these customers for our 1G HTS wire has provided us with valuable insights regarding the specifications for HTS wire required in many different applications. We are employing these insights in the design and development of our proprietary 2G HTS wire, which we believe will benefit us relative to companies that are developing 2G HTS wire products but do not have a 1G HTS wire product.

We have been successful in developing and producing 1G HTS wire with performance levels sufficient to meet the technical needs for applications such as power cables, utility generators, shipboard motors, dynamic synchronous condensers and several electromagnet applications including maglev trains. We believe our 1G HTS wire could meet the technical needs for these applications and in some cases, such as motors, generators and synchronous condensers, could also meet the commercial needs, including pricing. However, we expect our 1G HTS wire will be used primarily for prototypes and demonstration projects and that our 2G HTS wire, which we plan to be a “form, fit and function” replacement for 1G HTS wire, will be utilized in commercial superconductor applications.

[Table of Contents](#)

The price-performance ratio for HTS wire is obtained by dividing the selling price-per-meter (\$/m) by the amount of electrical current measured in kilo-Amperes (kA) the wire can carry. The current selling price of 1G HTS wire varies according to customer specifications. For many customers, the price is typically \$20 per meter. The corresponding price-performance ratio is \$160/kAm using 125 Amperes (0.125 kA) as the typical performance of our commercial wire today. We believe the price-performance ratio of HTS wire needs to be in the range of \$25/kAm to \$80/kAm to be commercially viable and that the size of the market addressed by HTS wire will continue to increase significantly as the price-performance ratio approaches \$25/kAm.

Our continuing emphasis on decreasing the cost of manufacturing HTS wire is now focused on 2G HTS wire because we believe the 2G HTS wire manufacturing processes we have chosen to utilize will yield reductions in manufacturing costs that will lead ultimately to an improvement in the price-performance ratio of 2G HTS wire by a factor of two to five times relative to 1G HTS wire.

The manufacturing process for 2G wire is significantly different from the process used to make 1G HTS wire. The manufacturing process for 1G HTS wire involves packing a powder of BSCCO material into a tube that is subsequently drawn, rolled and heat treated to produce a wire. 2G HTS wire is produced by coating multiple layers of materials on a metallic base, or substrate, as shown in the following figure. Each layer or coating utilized in the 2G HTS wire architecture must be produced with great precision in order to achieve the highest electrical performance in the YBCO superconductor layer within the wire.

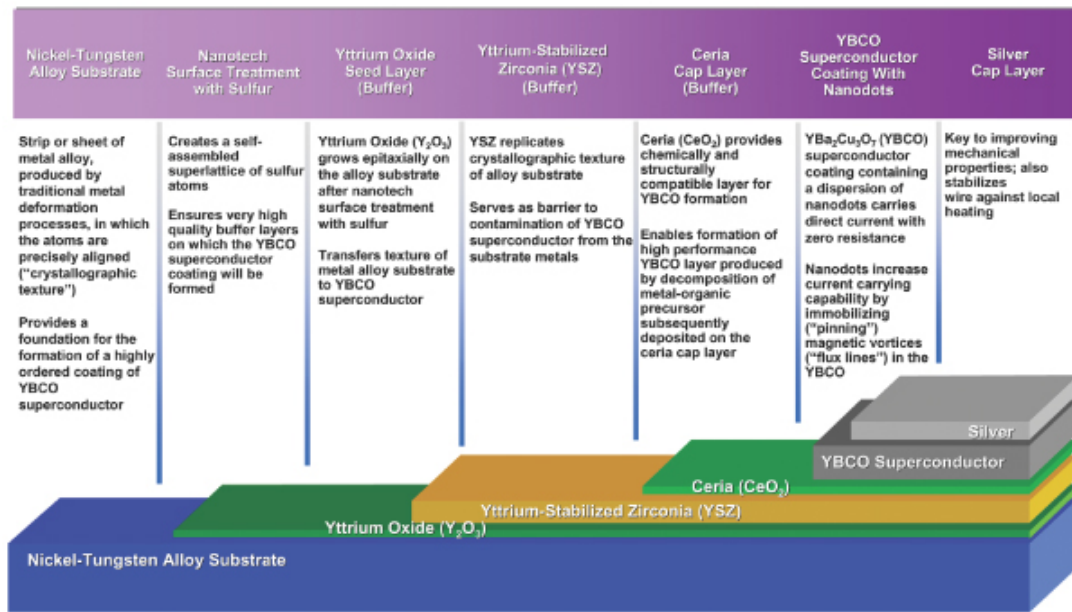

The amount of electrical current that can be carried by a superconductor wire typically decreases as the temperature of the wire in an application increases. The superconducting current drops to zero when the temperature is raised to the critical temperature,  $T_c$ . The superconducting current also decreases as the magnetic field to which the wire is exposed in an application increases – becoming zero at a critical magnetic field.

HTS wires utilized in applications such as power transmission cables are exposed to relatively low magnetic fields. We believe the short lengths of 2G HTS wire we have been developing already have the electrical performance levels required for use in power transmission cables. We believe our main challenge for this

## Table of Contents

application is scaling up our 2G HTS wire manufacturing process to produce wires as long as 1,000 meters on a commercial scale at commercially attractive costs. We believe our plan for scaling up our 2G HTS wire manufacturing process from the development stage to a pre-pilot operation and then to a pilot manufacturing operation will enable us to achieve commercial production of long lengths of 2G HTS wire in the next three to four years.

HTS wires utilized in the form of electromagnetic coils, in applications such as electric motors or generators, maglev train systems, and magnetic resonance imaging medical systems, are exposed to substantial magnetic fields created by the passage of current through the wire. In such applications, methods for enhancing the electrical performance of the HTS wires in the presence of strong magnetic fields need to be developed. This can be achieved by “pinning”, or immobilizing the magnetic vortices, or “magnetic flux lines”, within the superconductor wires as shown in the following graphic.

- Fundamental electromagnetism requires that current be surrounded by a spatially varying magnetic field
- In a superconductor, magnetic fields exist in nanometer-sized cylinders called magnetic vortices or flux lines
- For current to flow inside a superconductor, a spatially varying density of these flux lines has to be pinned by defects
- Nanodots (nanometer-sized particles) are one of the best pinning defects
- The better the pinning, the higher the maximum current

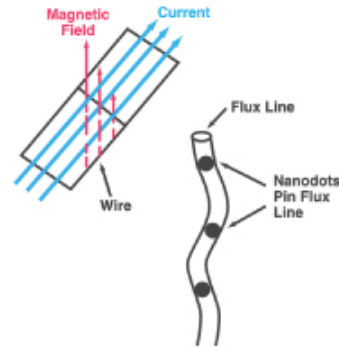

We believe we have developed a practical, low cost methodology for increasing the electric current in our 2G HTS wires in high magnetic fields. Our approach involves the careful introduction of a variety of defects into the superconductor, including a dispersion of tiny foreign particles or “nanodots”. Each type of defect has a different effect on the wire’s electrical performance, with the result being improved current carrying abilities under a range of temperature and magnetic field conditions. An yttrium oxide ( $Y_2O_3$ ) nanodot – approximately 100 atoms across – is shown in the following figure.

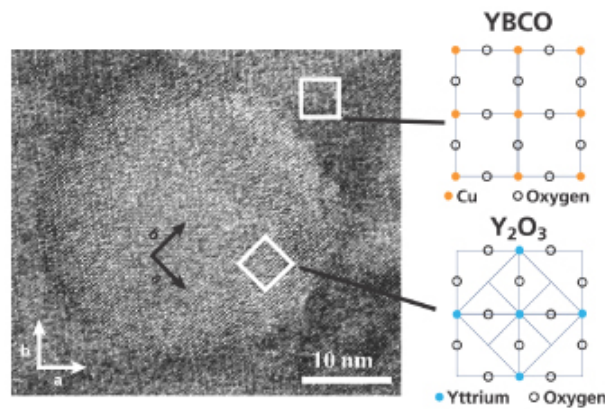

## [Table of Contents](#)

By careful selection of the manufacturing technique for the production of each of the layers in a 2G HTS wire, it is possible to produce a 2G HTS wire that has very high electrical performance while minimizing the costs associated with the production of each layer. We have over a period of eight years investigated many different techniques for manufacturing each of the layers in a 2G HTS wire. We have discovered and demonstrated a combination of manufacturing steps that yields 2G HTS wire with very high electrical performance. The manufacturing steps that we currently plan to utilize to manufacture 2G HTS wire are illustrated in the following figure.

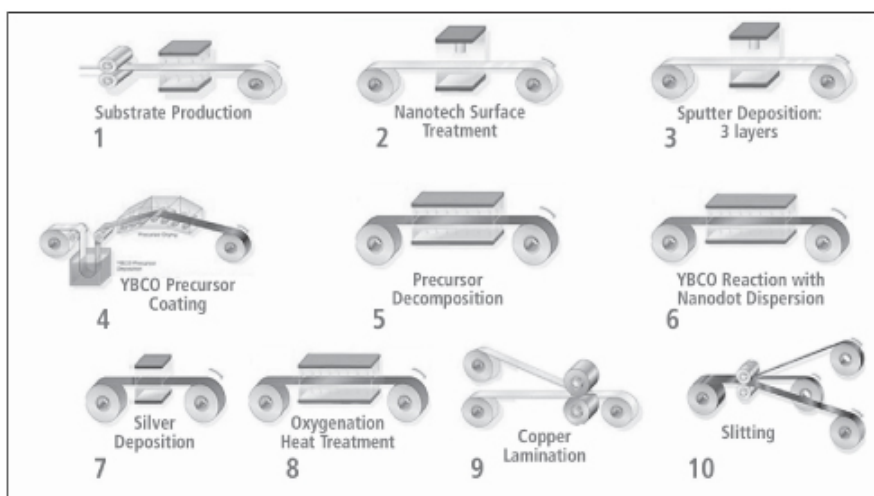

*Ten individual steps are utilized in our reel-to-reel manufacturing process for 2G HTS wire.*

We believe the manufacturing steps that we currently plan to utilize in the manufacture of 2G HTS wire will produce 2G HTS wire at substantially lower costs than the manufacturing techniques being pursued by competitors that are developing 2G HTS wire. We believe the performance and manufacturing costs inherent in our 2G HTS wire manufacturing process will give us a competitive edge in the commercial market for HTS wires. We have also developed a strong portfolio of patents related to our 2G HTS wire fabrication methodology, with over 65 worldwide patents and patent applications pending, and licenses to over 50 worldwide patents and patent applications owned by others. However, we can make no assurances that we will be successful in fully scaling up our proprietary 2G HTS wire manufacturing process.

In July 2004, we announced plans to complete the conversion of our 2G HTS wire development operation into a pre-pilot production line for 2G HTS wire. We expect the pre-pilot line, which will comprise both upgraded development equipment and production equipment, will be in operation by the middle of 2005. While the upgraded development equipment is located primarily in our Westborough facility, all of the new production equipment for the pre-pilot line will be located within our Devens manufacturing facility.

## [Table of Contents](#)

The pre-pilot line will have a substantially larger capacity than our current development operation. The pre-pilot line will also have the capability to produce 4-centimeter-wide strips of 2G material as shown below, substantially wider than the 1-centimeter-wide strips we produce in our development operation. The migration to 4-centimeter technology is important because it represents an opportunity for a significant reduction in manufacturing costs. We plan to slit the 4-centimeter-wide strips to the industry standard 0.4-centimeter-wide wires, which will produce multiple wires from one production run, thereby reducing overall manufacturing costs for a given quantity of wire produced.



We plan to manufacture and ship approximately 10,000 meters of 2G HTS wire from our pre-pilot line in the first 12 months of its operation. The primary customers for this 2G HTS wire will be our current customers for 1G HTS wire.

When the pre-pilot line meets our expectations for performance and yield for 2G HTS wire production, we plan to convert the pre-pilot line into a full pilot manufacturing operation. This pilot line will consist entirely of production equipment. Because our proprietary 2G HTS wire manufacturing technique is modular, we expect to be able to expand the pilot line to full commercial production, as dictated by market demand, by commissioning additional production modules. The full pilot line and the commercial manufacturing operation will be located in our Devens facility.

We believe we will be in a position to start to order the equipment for the full pilot line in the fall of 2005. The equipment cost for the pilot line, which we expect will have a production capacity of approximately 300,000 meters per year by December 2007, is expected to be \$10 million to \$15 million. The additional capital equipment needed for full commercial production is expected to cost approximately \$25 million to \$30 million, and should result in a commercial manufacturing operation with a gross capacity of approximately 7 million meters of wire per year. Our current plan is to have the commercial manufacturing operation in place by approximately December 2009. We believe we can accelerate this timeline if the market demand for our 2G HTS wire accelerates.



## [Table of Contents](#)

*Key Markets for HTS Wires (Power Cables).* We believe that an important application for our HTS wire is high-capacity AC and DC power cables. Because of the high power capacity of HTS wire, HTS power cables have the potential to carry up to 10 times more power, depending on the design and operating characteristics of the cable, than copper-wire cables of the same dimensions. The performance levels and mechanical properties of our HTS wire are sufficient today to meet the technical requirements for cables that can alleviate congestion in power transmission systems.

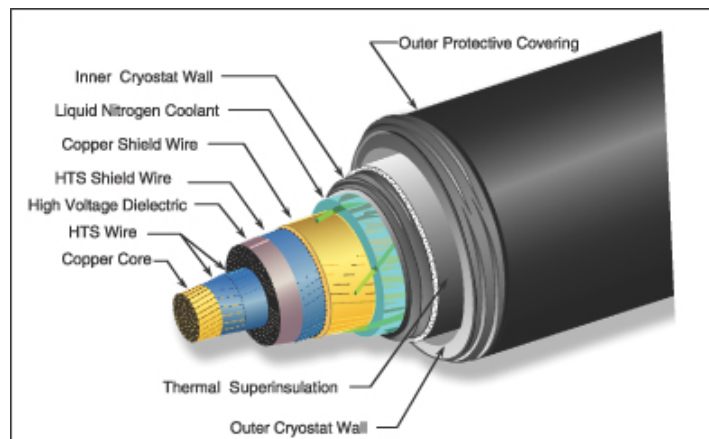

*Key components of a co-axial, cold dielectric superconductor power cable.*

There are several designs for HTS power cables that are being developed and tested by a number of cable manufacturers around the world. In all cases, the cryogenic coolant for the HTS wires in these cables is liquid nitrogen. Nitrogen, which comprises approximately 79 percent of the air we breathe, is an environmentally friendly, nonflammable material. When cooled by standard industrial refrigeration techniques, nitrogen gas turns into a relatively inexpensive liquid, which is used in many applications, from steel making to crushing of spices to cryogenic freezing of biological materials on farms.

HTS power cables must be thermally insulated from their surroundings to minimize the refrigeration expense associated with keeping the nitrogen in its liquid state, which, in turn, keeps the temperature of the HTS wire in the cable below its critical temperature. The cryogenic insulation, typically called a cryostat, is made in a variety of forms depending on the cable architecture. Cryostats of the type needed for HTS power cables have been manufactured for decades by companies such as Nexans and Vacuum Barrier. The kind of cryogenic refrigeration equipment needed for HTS power cables is typically made by companies such as Air Liquide, The BOC Group, Air Products and Chemicals, Praxair and others. Further developments to improve the costs of both cryogenic refrigeration and cryostats are necessary to catalyze broad market adoption of HTS cables.

HTS cables can provide a variety of advantages over conventional copper cables. Most important are the increased power density and very low impedance (VLI) characteristics of several HTS cable designs. These product features provide end user benefits in the following areas:

*Infrastructure Siting and Permitting.* Due largely to environmental and property value concerns, acquiring permits for overhead transmission lines has become an increasingly difficult process that can take over a decade to conclude without a guarantee of success. Conventional underground transmission cables that utilize copper or aluminum wires can be applied in some applications, but technical and environmental considerations limit widespread use. Co-axial HTS underground cables alleviate these concerns. With such HTS cables, fewer cables are needed to transmit the same amount of power, they have very low impedance, soil heating concerns are eliminated, and no stray electromagnetic fields (EMF) are produced.

*Relieving Network Congestion.* Co-axial HTS cables have VLI characteristics. Since electricity flows along the path of least impedance, these HTS cables can be used to change the flow dynamics of a transmission network. When properly placed into the transmission grid, HTS cables can be used to draw power flow away from overtaxed conventional cables or overhead lines and expand the overall system capacity with minimal new infrastructure or disruption.

*Controlling Power Flow.* VLI HTS cables have another significant benefit. Because they have very low impedance, AC power flow through them can be controlled with conventional series reactors or phase shifters. The free-flowing nature of the AC grid has emerged as an obstacle to efforts to restructure and deregulate the electric power industry, and experts now recognize that improved power flow control is necessary to enable these reforms to succeed. Historically, power flow has been controlled by converting AC power to DC power. This requires the use of inverters and rectifiers that are much more expensive than series reactors and phase shifters. Even if DC power is chosen, HTS cables may be the best choice. DC HTS circuits double the ampacity of similar sized AC HTS circuits and can provide up to 10 times the amperage of similar-sized conventional DC cables. In larger DC power applications the economics of HTS cables are superior to conventional DC circuits.

*Reduced Construction Costs.* For many years, urban retrofit projects have been recognized as an ideal application for HTS cables. In many urban areas the demand for power has outgrown the existing infrastructure. Solving this problem with conventional technology incurs the major disruption and large expense associated with digging up streets to install new conduit systems. Because HTS cables transmit significantly more power than conventional cables, in many cases it is possible to replace existing cables in existing conduits with HTS cables, and more than triple the available power without trenching or other disruptive and costly construction activities. Even when trenching is needed to install cables in new transmission corridors, the disruption and expense is much less since fewer HTS cables are needed and multiple HTS cables can be put in one trench without creating heating problems.

*Voltage Reduction.* The high amperage characteristics of HTS cables allow significant reductions in voltage without a reduction in total power transferred. This can result in significant savings in support infrastructure such as substations, terminations, splices, etc. In addition, the ability to transmit large amounts of power at lower voltages can often eliminate the need for locating substations in sensitive or expensive sites. Also, the permitting cycle for lower voltage additions to the transmission system have greater predictability, quicker approvals and a much greater chance of being approved.

*Lower Power Losses.* HTS wire transmits DC power with zero resistive losses. This feature makes DC HTS circuits nearly perfect conductors. On a net loss basis (including energy consumed for refrigeration) DC HTS circuits and most AC HTS circuits consume less energy than conventional circuits.

*More Secure Power Networks.* Security of power networks is becoming a growing concern, and power grid operators have a need for new technology solutions that will enable their networks to become self protecting. Self protecting networks adjust rapidly and automatically to disruptions in power network equipment caused by weather damage, willful destruction or other reasons. We believe that VLI superconductor cables, because of their capacity, controllability and impedance characteristics, can play a significant role in conjunction with other technologies in creating more secure power networks.

## [Table of Contents](#)

In order for electric utilities and power grid operators to adopt HTS cables, they must first observe the successful testing and operation of HTS cables in high voltage test facilities and in actual power grid installations. The first phase of HTS cable demonstrations began in 1996 and ended in approximately the first half of 2003. The demonstration projects involved in the first phase were highly successful; only the Detroit Edison HTS cable project, which was run by Pirelli Energia e Sistemi (Pirelli), fell short of its goal when leaks developed in the cable's thermal insulation system (the cable cryostat). The list of projects in the first phase includes:

- Pirelli: 50m, 115kV, 2000 A, Pirelli test facility (1996-1999);
- Pirelli: 120m, 24 kV, 2400 A, Detroit substation (2000-2002);
- Sumitomo: 30m, 66 kV, 1000 A, TEPCO test facility (1996-1999);
- Sumitomo: 100m, 66 kV, 1000 A, TEPCO test facility (2000-2002);
- Southwire: 30m, 12.5 kV, 2600 A, Southwire manufacturing plant (1998-Present);
- nkt cables: 30m, 30 kV, 2000A, Copenhagen substation (1999-2003); and
- Condumex: 5m, 2000 A, Condumex test facility (2001-2002).

The second phase of HTS cable demonstrations includes eight to ten new cable projects that are currently underway or are expected to be underway by 2006. We anticipate these demonstrations will occur in the U.S., Europe, China, Korea, Japan and Mexico. In April 2003, we were selected by the DOE as prime contractor to install a half-mile long, 600 megawatt (MW), 138 kilo-Volt (kV) HTS cable system in the power grid of Long Island Power Authority (LIPA). We selected Nexans as our subcontractor to manufacture the HTS cable, the cable cryostat and the cable terminations, and we selected Air Liquide to provide the cryogenic system design and the refrigeration equipment. We expect to produce approximately 160,000 meters of HTS wire for this project. We plan to deliver all of this wire to Nexans by July 2005 and we expect the cable system to be installed in the first quarter of calendar year 2006.

The DOE will provide project financing and technical review for the LIPA cable project. The cable system is being designed to become a permanent part of the LIPA power grid. This project is viewed by LIPA as the first phase of an HTS circuit that will provide power to much of Long Island. We view this project as a major step toward commercial HTS cable sales. We are currently discussing commercial power cable applications with several potential end users in the U.S. and abroad. There can be, however, no assurance that operators of transmission and distribution grids will adopt HTS power cables after the demonstration projects are complete. To the extent that HTS cables are adopted for commercial applications, we believe our 1G HTS wire will be competitive and that we will have a significant market for our HTS wires in power cable applications.

*Key Markets for HTS Wire (Utility Generators).* We believe another significant market for our HTS wire will be utility generators that produce 100 MVA or more of power. Benefits of using HTS wires in these generators include improved VAR control, longevity (HTS generator coils run "cold," so there are no thermal stresses), smaller size, weight and footprint, improved energy efficiency, and potentially lower costs. GE Energy, a business of the General Electric Company, is currently developing a 100 MVA HTS electrical generator using our wire. We have been selected by GE Energy as the wire supplier for this project. Over the last four years, we have supplied HTS wire to GE Energy for test purposes.

The first HTS rotor for a 100 MVA generator is being developed by GE Energy using 1G HTS wire. GE Energy has stated that it prefers to adopt 2G HTS wire for its generator design because it believes 2G HTS wire will provide significant cost and mechanical performance advantages for its particular generator design.

## [Table of Contents](#)

The four primary manufacturers of utility generators are GE Energy, Alstom Power, Siemens-Westinghouse and Mitsubishi Electric. We are currently marketing our HTS wire to all of these generator manufacturers with the goal of becoming the primary wire supplier to each of them; however, we can make no assurances that these generator manufacturers will develop commercial HTS generators and, to the extent they are successful, that they will choose our HTS wire.

*Key Markets for HTS Wire (Rotating Machines).* Our SuperMachines business unit produces rotating HTS machines and is a customer for wire produced by our AMSC Wires business unit. AMSC Wires also sells its HTS wire to other manufacturers of rotating machines. The SuperMachines business is focused on electric motors and generators for marine propulsion and on synchronous condensers for power grid reliability. A review of this business unit's products and markets is provided later.

We believe the market for HTS wire for electric motors and generators will be large and we believe we are in a position to capture a significant share of this market; however, we cannot provide assurance that a market for HTS electric motors, generators and synchronous condensers will develop or, to the extent that it does, that our HTS wire will be purchased by the manufacturers of these machines.

*Other HTS Wire Applications.* Over the last several years we have sold our HTS wire to a number of OEMs and research and development organizations that are developing other applications for HTS wire. In March 2004 we successfully completed the construction of an HTS electromagnet for a commercial-scale industrial magnetic separator for Dupont. This was a follow-on order to the electromagnet we delivered three years ago to Dupont for a prototype magnetic separator. The new prototype electromagnet met all performance specifications and awaits operation in actual magnetic separation processing.

We have also sold HTS wire for transportation, military, medical and other applications. Many of these applications, such as transformers and fault current limiters, are in the early development stage. We believe that 2G HTS wire will facilitate applications such as transformers and fault current limiters because it has favorable physical properties for these applications.

During the fiscal year ended March 31, 2004, we sold our 1G HTS wire to Central Japan Railway for use in a prototype electromagnet to be used in a maglev train system. Central Japan Railway reported in May 2004 that the wire met their needs for electrical performance and robustness and was likely to lead to lower costs for maglev train systems. We have shipped a significant amount of our HTS wire to Central Japan Railway in the fiscal year ending March 31, 2005 for application in additional prototype electromagnetic coils for maglev trains.

Some of these other applications have the potential to become important markets for our HTS wire, and we will continue to market our HTS wire to the developers of these and other new products. We cannot make any assurances, however, that these markets will develop, that they will become significant markets or that our HTS wire will be purchased for use in these markets.

*Sales and Marketing for HTS Wire.* We plan to sell wire to a broad OEM market, and we are aiming for a high market share, which we plan to protect by being the market leader in performance, cost, service and intellectual property. We are focusing our business and market development efforts on key OEMs that we believe are the market leaders. By establishing strong relationships with these market leaders we can foster more rapid market development and have a significant impact on industry standards. Most of our key OEMs are serviced by our direct sales force. However, in some areas we have found it advantageous to form sales alliances to establish ourselves in the market. For example, in the fall of 2001, we signed a multi-year distribution agreement with Kiswire Ltd., a leading Korean wire manufacturer, to distribute HTS wire in the Korean market.

As a result of our collaboration with Kiswire, we were chosen to be a supplier of 1G HTS wire for the Korean national superconductor program, which has led to sales and follow-on orders for our HTS wire. We have also made significant inroads into China, which has the world's second largest electric power generation capacity. During the last 12 months, we have shipped approximately 30,000 meters of our HTS wire to China for use in two electric power projects.

## [Table of Contents](#)

Our Advanced Grid Solutions business development team, described earlier, is helping us build demand for HTS wire and further penetrate key markets. We are leveraging this team's experience in transmission planning by working with utilities to identify locations in their system where HTS solutions would add value to their power grids. We are also applying the team's project management experience to facilitate project concept development, close orders and implement projects.

*Competition for HTS Wires.* We face competition both from vendors of traditional wires, such as copper, and from competitors who are developing HTS wires. There are several companies around the world that are our competitors in the market for 1G HTS wire. They presently include Sumitomo Electric Industries (Japan), Furukawa Electric (Japan), European Advanced Superconductor, a division of Bruker Biospin (Germany), Innova Superconductor Technology Co. Ltd. (China) and Trithor GmbH (Germany).

We also face competition in 2G HTS wires from a number of companies in the U.S. and abroad. These include: Intermagnetics General Corporation-Superpower and MetOx in the U.S.; Sumitomo Electric, Fujikura, Furukawa and Showa in Japan; and Nexans, Trithor, Theva, Evico and EHTS, a University of Goettingen spinout acquired by European Advanced Superconductor, in Europe. Impressive laboratory results have been achieved by some of our 2G HTS wire competitors. However, we believe that the proprietary processes we have adopted will prove to be the best processes to provide not only high performance wire, but also commercial quantities at the lowest cost. In particular, four of these competitors, Sumitomo Electric, Nexans, Trithor and Showa, have recently focused their research programs on the development of 2G HTS wire made by the same or similar processes we have chosen to utilize to manufacture 2G HTS wire. We view this development as a validation of our conclusion that our proprietary 2G HTS wire process is the best to provide high performance 2G HTS wire in commercial volumes at the lowest cost. We believe we have a significant technical and manufacturing scale-up lead on these and any other companies that decide to try to duplicate our propriety 2G HTS wire manufacturing process. We also believe that we have a strong intellectual property position, including patent rights and know-how, that will help us maintain a competitive advantage in the area of 2G HTS wire products. However, there can be no assurance that this will be the case.

Many of our competitors have substantially greater financial resources, research and development, manufacturing and marketing capabilities than we do. In addition, as HTS wire markets develop, other large industrial companies may enter these fields and compete with us.

### ***SuperMachines Business***

Our SuperMachines business unit is responsible for the design, development, manufacturing, testing and commercialization of HTS electric motors with power ratings up to approximately 50,000 hp (37.5 MW), generators with power ratings generally in the range of 20 to 100 MVA, and dynamic synchronous condensers with reactive power ratings up to 50 mega-VAR (MVAR). This business buys HTS wire from our AMSC Wires business and winds the wire into electromagnetic coils of various sizes and shapes, which we incorporate into the rotors of motors, generators and dynamic synchronous condensers, all of which are AC synchronous rotating machines. In such rotating machines, the rotor coils utilize DC, to which our HTS wire exhibits zero electrical resistance, a feature that typically cuts the electrical losses of AC synchronous rotating machines in half compared with copper wire-based machines.

The use of HTS wire in rotating machines provides us with significant competitive advantages by enabling dramatic reductions in size, weight and manufacturing costs relative to conventional machines. Because of the manufacturing cost reductions associated with the reduced size of our HTS rotating machines, we expect the market price of our rotating machines to be equivalent to that of copper-based machines at the same power and torque rating. The advantages of HTS rotating machines in ship propulsion applications are summarized in the following figure:

### HTS Ship Propulsion Motors

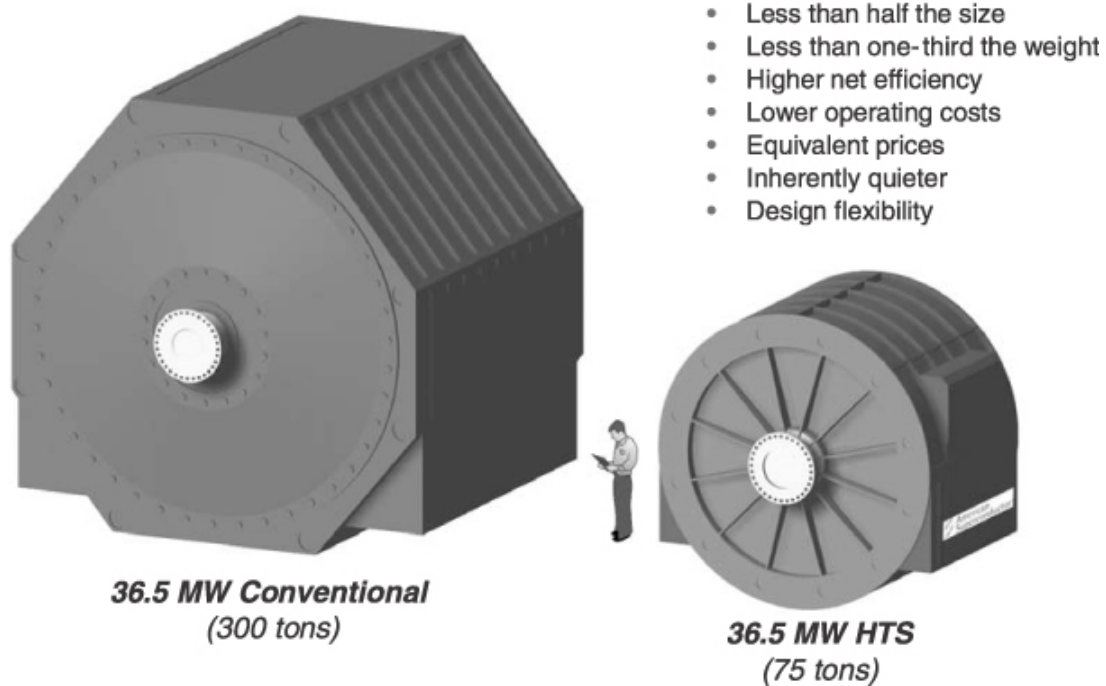

The HTS rotor coils in our superconductor rotating machines are cooled using commercially available mechanical refrigerators located near the machine, which cool the rotor using our patented techniques. We are also developing new refrigeration technology that we believe could further reduce the cost of cryogenic cooling.

The cooling systems used for HTS motors, generators and dynamic synchronous condensers are closed loop, meaning that the cooling medium circulates inside a closed system from the region of the HTS coils on the rotor, where the cooling medium picks up heat, to the cold head of the refrigerator, where the cooling medium releases heat and is chilled again. The cooling media we typically use for our rotating machines are either liquid neon or gaseous helium. In the case of our neon systems, the liquid neon absorbs heat by turning into a gas, which is condensed back to liquid at the cold head outside the rotating machine—much like the cycle in home refrigerators. In the case of gaseous helium, no liquid phase is involved.

Our AC synchronous rotating machines have a higher net efficiency, including the losses associated with the cooling system, than conventional machines of the same power rating. This efficiency gain is particularly noteworthy when an HTS rotating machine is operated at part load, such as in marine propulsion applications when a ship is moving at slow speeds. The stator coils in our AC synchronous machines utilize copper windings, which are cooled either with air, oil or water, in a manner similar to that used for conventional motors and generators.

Our SuperMachines business unit is experienced in HTS rotating machine design, development and testing, and has built a significant portfolio of intellectual property, much of which is protected by more than 43 U.S. and 55 international patents and patents pending. We believe that we are well positioned to transform a 100-year-old rotating machine industry with our innovative HTS technology. Our history of involvement in the development of HTS rotating machines is shown in the following figure:

**AMSC's HTS Rotating Machine Development History**

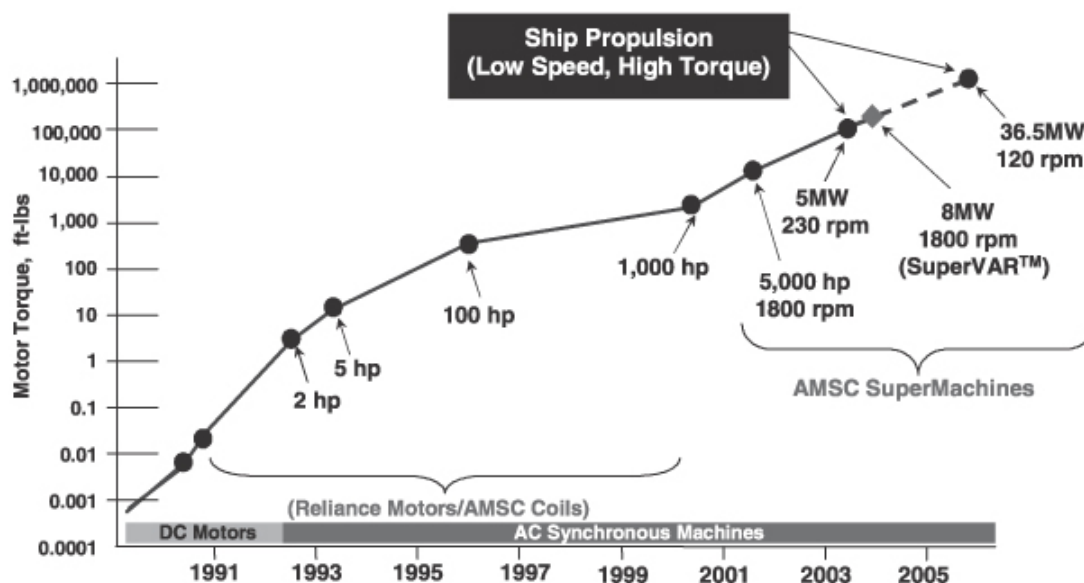

In January 2003, TVA awarded SuperMachines a contract for the design, fabrication and delivery of a prototype and an order for the first five commercial SuperVAR dynamic synchronous condensers to be used to enhance power grid stability by generating reactive power at critical locations in its power grid. The prototype is undergoing extensive testing in the TVA power grid in Tennessee. Upon successful completion of prototype testing, SuperMachines expects to build five commercial units, the first of which is expected to be delivered to TVA in the fiscal year ending March 31, 2006.

In February 2003, SuperMachines was awarded a competitively bid contract by the U.S. Navy to design and manufacture a 36.5 MW, 120 rpm HTS marine propulsion motor. This motor, which is on schedule for delivery in 2006, is expected to be evaluated by the Navy for possible use in its new class of electric warships, which it plans to deploy this decade. This contract, worth approximately \$70 million including certain performance incentive fees, is the largest contract in our history and represents a major milestone in the development of HTS rotating machines in general, and of military and commercial ship propulsion motors, in particular. This contract represents the fifth in a series of U.S. Navy awards to SuperMachines since 1999 for the conceptual and preliminary design of HTS ship propulsion motors and the development and manufacture of such motors.

In addition to these two important contract awards, SuperMachines completed the design and assembly of a 5 MW, 230 rpm HTS marine propulsion motor for the U.S. Navy in February 2003. The prototype ship propulsion motor was delivered on schedule to the U.S. Navy in July 2003 and installed for testing at the Navy-funded Center for Advanced Power Systems at the Florida State University in Tallahassee. It has successfully completed full load testing (full power at full torque) in which it produced its rated 5MW, and is undergoing

## [Table of Contents](#)

continuing testing simulating ship operating profiles. Further work on this project is subject to the appropriation of additional government funding.

**Manufacturing, Sales and Marketing for HTS Rotating Machines.** Our SuperMachines business currently operates out of a 27,000-square-foot facility in Westborough, Massachusetts. Operations conducted here include machine design, coil development, manufacturing and testing, exciter development, assembly and testing, and motor assembly and testing. We outsource the manufacture of copper-based stators, which we use in our HTS motors, to conventional motor manufacturers. We also outsource other components that are used in our HTS motors that are not unique to HTS rotating machines. The manufacture of the HTS coils, refrigeration system and exciter are completed internally along with the rotor assembly. In the fiscal year ended March 31, 2004, we outsourced both the stator design and fabrication for our SuperVAR machine and the stator coil fabrication for the 36.5 MW ship propulsion motor to Ideal Electric Holding (Ideal Electric), Mansfield, Ohio. In addition, we subcontracted the final assembly and testing of the 36.5 MW motor to the Marine Systems Division of Northrop Grumman Electronic Systems, Sunnyvale, California.

Our plan for future manufacturing, sales and marketing of HTS rotating machines is to form a business alliance with one or more motor manufacturers and/or marine propulsion system integrators. In October 2004, we signed such an agreement with Northrop Grumman Marine Systems for the U.S. military market. We believe this approach will provide us with more effective and quicker paths to manufacture motors and generators, as well as access to established sales and distribution channels and experienced sales teams. We also believe this approach will accelerate market adoption of our new HTS rotating machines. We are currently working with Alstom, Northrop Grumman Marine Systems and Ideal Electric as subcontractors for our rotating machine development and demonstration programs. We expect to create additional business alliances, similar to the Northrop Grumman Marine Systems relationship, as we enter the commercial markets for HTS rotating machines over the next several years.

**Competition for HTS Rotating Machines.** We face competition for our high-power HTS rotating machines from companies that manufacture traditional machines made with copper wires including: GE Energy, Siemens, Asea Brown Boveri Ltd. (ABB), Alstom, Toshiba, Ideal Electric, Brush Industries and Hitachi.

We also face competition from manufacturers of permanent magnet motors, which have been under development over the last decade. Permanent magnet motors are another technology being considered by the U.S. Navy for electric drives. Companies developing high-power permanent magnet motors include Siemens, ABB, General Dynamics and DRS Technologies. There are also at least two companies, Rockwell Automation and Siemens, that are developing HTS electric motors, or who have demonstrated HTS motors over the last several years.

Many of our competitors have substantially greater financial resources, research and development, manufacturing and marketing capabilities than we do. In addition, as HTS rotating machine markets develop, other large industrial companies may enter these fields and compete with us.

### ***Power Electronic Systems Business***

Our Power Electronic Systems business unit designs, develops, assembles, tests and sells power electronic converters that rapidly switch, control, and modulate power. This business unit is responsible for product development, marketing and sales of our proprietary PowerModule™ power electronic converter to OEMs, which integrate this product into electric motor drives, distributed and dispersed generation devices, such as micro-turbines, fuel cells and wind turbines, and power quality solutions, such as battery and flywheel-based uninterruptible power supplies. We expect that our PowerModule power converters will encompass power ratings from 60 to 1,000 kW per PowerModule power converter.

Our PowerModule power converters utilize a proprietary printed circuit board design that enables us to incorporate a microprocessor into the power converter and create programmable power converters.



## [Table of Contents](#)

Programmability is important because individual PowerModule converters or integrated stacks of PowerModule converters can be programmed to meet the needs of different customers to control and condition varying levels of power from tens of kilowatts to megawatts across a wide range of applications.

Flexibility, scalability and high power density are key PowerModule power converter product features. We believe the PowerModule power converter design will allow us to reduce the manufacturing costs of power electronic converters at power levels above 60 kW.

In addition to PowerModule power converter hardware, our Power Electronic Systems business unit is responsible for software development for the PowerModule power converters, as well as for the software needed to integrate the PowerModule power converters into final systems.

Our primary commercial PowerModule product today has a power rating of 250 kW. This product is known as the PM250 and it is the power converter we currently use in our commercial distributed superconductor magnetic energy storage (D-SMES), dynamic VAR (D-VAR<sup>®</sup>) and power quality industrial voltage restorer (PQ-IVR<sup>™</sup>) product lines.

We have completed the development of our next generation of PowerModule power converters, which we call the PowerModule 1000<sup>™</sup>, or PM1000<sup>™</sup> power converter. The PM1000 power converter family features a scalable, modular and flexible design architecture. It is an intelligent and fully integrated power converter that has a compact package design and yields a very high power density of up to 130 Watts/cubic inch. Features of this design include:

- state-of-the-art IGBT technology;
- scalable design;
- flexible architecture; and
- high power density.

In 2004, we delivered our first two products based on the PM1000 power converters. These products included a 2 MW generator power conditioning and control system for the Royal Navy (of Great Britain) and components for the pulsed power system of a new electric weapons platform for the U.S. Army. In addition, we have obtained our first order for PM1000s to be utilized for power flow control of a wind turbine. We believe these orders represent a good foundation upon which we can build additional sales of PM1000 power converters.

The Power Electronic Systems business unit also develops, markets and sells products that provide customer benefits further up the power electronics value chain by offering a line of power quality and reliability solutions based on our PowerModule power converters, as shown in the following chart.

### Power Electronic Systems Value Chain

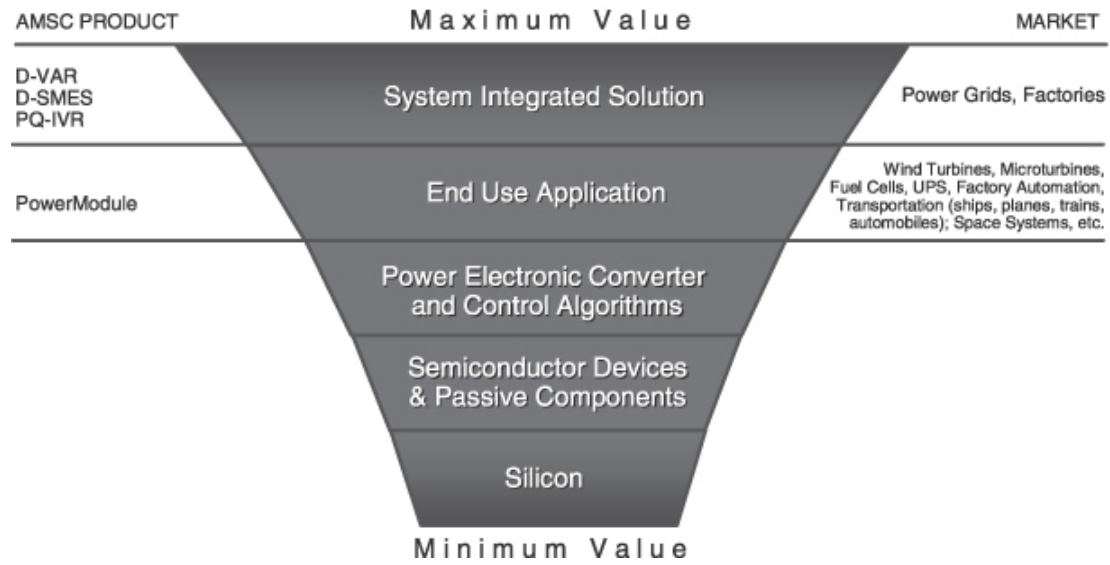

Our power quality and reliability solutions are used in a variety of transmission grid, wind farm and manufacturing applications. The systems are based on our PowerModule power converters and may be integrated with a SMES device, which can store and inject large quantities of real power along with the reactive power from the PowerModule converters. Our commercial integrated power electronic systems include the following:

**PQ-IVR™** - Our PQ-IVR systems are installed in transmission substations that bring power into industrial manufacturing sites. These systems protect manufacturing operations from the adverse effects of momentary voltage sags. PQ-IVR systems detect voltage drops on the power lines coming into manufacturing sites and instantly inject power into the lines to restore the voltage to the required range of operating voltages. A PQ-IVR may include a SMES device along with the integrated PowerModule converters if the particular customer site requires the injection of real power in addition to reactive power. Our transmission planning team works with industrial customers to determine the optimum configuration for each industrial site. Our PQ-IVR systems protect entire manufacturing operations that have electrical loads over 5 MW (as opposed to lower power, point-of-use protection devices that must be installed at various sites within the manufacturing operation). We believe our PQ-IVR systems provide a cost-effective solution to the problem of voltage sags, which can cost manufacturers millions of dollars in downtime, damaged equipment and lost work-in-process. A major target customer for PQ-IVR systems are semiconductor manufacturers because they are well aware of the impact of voltage sags on productivity and the resulting high cost of downtime.

**D-VAR®** - Our Dynamic VAR (D-VAR) product, which comprises an integrated array of our PowerModule power converters, offers a powerful yet cost-effective way of regulating and stabilizing voltage levels by injecting reactive power (VARs) into the power grid at precise locations where voltage problems can occur. This restores the voltage of the power grid to normal levels. D-VAR systems enable operators to increase large-scale power flow through existing transmission lines, significantly increasing power grid asset utilization. D-VAR systems are also a cost-effective and readily deployable solution. Given these factors and the current federal

## [Table of Contents](#)

emphasis on increasing transmission capacity and reducing related regulatory hurdles, we expect demand for D-VAR systems by utilities and transmission companies to grow as investment in grid infrastructure increases and regulatory barriers fall.

*D-SMES - Distributed SMES (D-SMES) systems* comprise a D-VAR with a superconductor storage magnet to provide a source of real power. D-SMES systems protect electric utilities by stabilizing voltage in power grids through the simultaneous injection of large amounts of reactive power from an array of PowerModule converters and real power from the superconductor magnet. The primary difference between the D-VAR and D-SMES systems is that a D-VAR system does not contain a SMES device. The decision of whether to incorporate a SMES device into a power grid reliability solution is dependent on site specific issues. This flexibility enables us to provide the most cost-effective solution for each application.

*Transmission Planning Capabilities.* Our Power Electronic Systems business unit has in-depth knowledge of and extensive experience in the design and structure of transmission and distribution grids. Its Transmission Planning Group uses sophisticated software programs to perform analyses of the effects of disturbances in power grids to determine grid reliability under normal and peak loading conditions. This group also analyzes the effects of the incorporation of standard technologies such as capacitors and static VAR compensators (SVCs) and advanced technologies such as HTS cables, D-SMES systems, D-VAR systems and SuperVAR synchronous condensers into power grids. They perform similar analyses to determine the optimum power quality solution for industrial manufacturing sites. Our Transmission Planning Group plays a significant role in the sales and marketing of our power electronic systems products and solutions.

*Manufacturing, Sales and Marketing of Power Electronic Systems.* Our Power Electronic Systems business unit operates out of facilities in New Berlin and Middleton, Wisconsin. In New Berlin, we design, develop and test our PowerModule power electronic converters. We outsource the manufacture of PowerModule power converters allowing us to focus on our core competency of design and final test of PowerModule systems. We assemble and test components and PowerModule power converters for incorporation into our integrated power electronic systems such as D-SMES, D-VAR and PQ-IVR systems in our Middleton, Wisconsin facility. We plan to outsource the manufacture of superconductor magnets needed for D-SMES systems, which allows us to focus on our core competency of integrating components for our commercial power quality and reliability systems.

In April 2000, we entered into a co-marketing and sales alliance with GE Industrial Systems (GEIS), a business of General Electric, to market and sell co-branded D-SMES systems on an exclusive basis to North American electric utilities. The alliance agreement was expanded to include the marketing and selling of co-branded D-VAR systems once we introduced this new product in May 2002.

The co-marketing and sales alliance with GEIS was transferred to GE Energy, also a business of General Electric, in 2003. In June 2003, we renewed and expanded our co-marketing sales alliance to include co-marketing and sales of D-VAR and D-SMES systems to South American electric utilities. We also agreed to sell co-branded PQ-IVR systems with GE to certain industrial customers.

Our joint sales and marketing tactics include calls on customers using members of both our and GE Energy's direct and regional sales teams. We believe the addition of the GE Energy sales teams adds significant strength to our sales efforts.

Our sales of individual PowerModule power converters are managed by our direct sales force in the U.S. and in Europe. We have sold and intend to sell both individual PowerModule power converters as well as integrated PowerModule power converters for applications such as motor drives, uninterruptible power supplies, wind turbines, and distributed generation applications.

*Competition for Power Electronic Systems.* We face competition from other companies selling power reliability products, such as SVC and STATCOM (Static Reactive Compensation) products made by ABB, Alstom, Siemens and Mitsubishi Electric Power Products, DVRs (dynamic voltage restorers) produced by

## [Table of Contents](#)

companies such as S&C Electric and ABB, and flywheels and battery-based UPS systems offered by various companies around the world. We do not know of any companies currently selling commercial SMES products; however, there are at least two organizations developing SMES products, a government-sponsored program in Japan and ACCEL Instruments GmbH in Germany.

We face competition from companies that are developing power electronic converters for use in applications for which we expect to sell our PowerModule products. These companies include Ecostar, Inverpower, SatCon, Semikron and Xantrex.

Many of our competitors have substantially greater financial resources, research and development, manufacturing and marketing capabilities than we do. In addition, as the power quality and reliability markets develop, other large industrial companies may enter these fields and compete with us.

### **Patents, Licenses and Trade Secrets**

#### ***Patent Background***

An important part of our business strategy is to develop a strong worldwide patent position in all of our technology areas. Our patent portfolio comprises both patents we own and patents we license from others. We devote substantial resources to building a strong patent position and we believe that we have significantly strengthened our position in the past several years. As of December 31, 2004, we owned (either alone or jointly) more than 145 U.S. patents and over 50 U.S. patent applications (jointly or solely owned) on file. We also hold licenses from third parties covering over 130 issued U.S. patents and over 25 U.S. patent applications. Together with the international counterparts of each of these patents, patent applications and licenses, we own more than 390 patents and patent applications worldwide, and have rights through exclusive and non-exclusive licenses to more than 375 additional patents and patent applications. We believe that our current patent position, together with our expected ability to obtain licenses from other parties to the extent necessary, will provide us with sufficient proprietary rights to develop and sell our products. However, for the reasons described below, there can be no assurance that this will be the case.

Despite the strength of our patent position, a number of U.S. and foreign patents and patent applications of third parties relate to our current products, to products we are developing, or to technology we are now using in the development or production of our products. We may need to acquire licenses to those patents, or to successfully contest the scope or validity of those patents, or to design around patented processes or applications.

If companies holding patents or patent applications that we need to license are competitors, we believe the strength of our patent portfolio will significantly improve our ability to enter into license or cross-license arrangements with these companies. In July 2003, we executed a cross license agreement with Sumitomo Electric under which we licensed to each other North American and European patents related to 1G HTS wires, electromagnetic coils, electromagnets and current lead devices. However, there can be no assurance that we will be able to obtain all necessary licenses from competitors on commercially reasonable terms, or at all.

We may be required to obtain licenses to some patents and patent applications held by companies or other institutions, such as national laboratories or universities, not directly competing with us. Those organizations may not be interested in cross-licensing or, if willing to grant licenses, may charge unreasonable royalties. We have successfully obtained licenses from a number of such organizations, including Lucent Technologies, Superlink of New Zealand, ORNL, MIT, and Toshiba in Japan, with royalties we consider reasonable. Based on past experience, we expect that we will be able to obtain other necessary licenses on commercially reasonable terms. However, there can be no assurance that we will be able to do so.

Failure to obtain all necessary licenses upon reasonable terms could significantly reduce the scope of our business and have a materially adverse effect on our results of operations. We do not now know the likelihood of successfully contesting the scope or validity of patents held by others. In any event, we could incur substantial

## [Table of Contents](#)

costs in challenging the patents of other companies. Moreover, the nature of HTS patents is such that third parties are likely to challenge some of our patents or patent applications, and we could incur substantial costs in defending the scope and validity of our own patents or patent applications whether or not a challenge is ultimately successful.

### ***HTS Patents***

Since the discovery of high temperature superconductors in 1986, the HTS industry has been characterized by rapid technical advances, which in turn have resulted in a large number of patents, including overlapping patents, relating to superconductivity being applied for and granted worldwide. As a result, the patent situation in the field of HTS technology and products is unusually complex.

At any given time, we will have a preference for using one or a few specific HTS materials in the production of our products. Any HTS material we use is likely to be covered by one or more patents or patent applications held by other parties. We have obtained licenses to patents and patent applications covering some HTS materials, including an exclusive license from Superlink and non-exclusive licenses from Lucent Technologies and Toshiba. However, we may have to obtain additional licenses to HTS materials.

As we currently have two methodologies for producing HTS materials into wire, known as 1G and 2G, our strategy is to obtain a proprietary position in both methodologies through a combination of patents, licenses and proprietary know-how. If alternative processes become more promising in the future, we will also seek to develop a proprietary position in these alternative processes.

We have filed a number of patent applications that are applicable to 1G and 2G HTS wire architectures. Some of these applications have been issued as patents in the U.S. and abroad, while others are pending. We have acquired an exclusive license from MIT and non-exclusive licenses from ORNL and Lucent Technologies to intellectual property relating to 2G, and non-exclusive licenses from Lucent Technologies, Sumitomo Electric and Toshiba relating to the production of 1G HTS wire. We have also acquired certain intellectual property rights in the 2G area through our collaboration with EPRI.

We have an exclusive license from MIT under an issued U.S. patent that covers the architecture of 1G and 2G HTS wire, specifically the composite of HTS ceramics and noble metals such as silver. The scope of this patent was the subject of an action in the U.S. District Court of Massachusetts. In September 2002, the court ruled in our favor. We were also issued patents on laminate structures for 1G HTS wire and on new architectures for 2G HTS wire that involve lamination technology.

A number of other companies have also filed patent applications, and in some instances these have become issued patents, on various aspects of wire processing and wire architecture. To the extent that any of these issued or pending patents might cover the wire processing methodologies or wire architectures we use, we may be required to obtain licenses under those patents; however, there is no assurance that we will be able to do so.

### ***HTS Component and Subsystem Fabrication Patents; HTS Application Patents***

We have received several patents and filed a significant number of additional patent applications regarding:

- the design and fabrication of electromagnetic coils and electromagnets;
- the integration of these products with an appropriate coolant or cryocooler;
- the application of these products to specific end uses; and
- HTS motor, generator and synchronous condenser designs.

Since the HTS rotating machine field is relatively new, we believe we are building a particularly strong patent position in this area. A number of other companies have also filed, and in some instances have received, patents on various applications of HTS component and subsystem fabrication methods. If any existing or future patents cover any of these aspects of our operations, we may be required to obtain licenses under those patents.

## [Table of Contents](#)

### ***Power Electronic Systems***

We have received several patents and filed a significant number of additional patent applications on power quality and reliability systems, including the D-SMES and D-VAR concepts. We have acquired a non-exclusive license from Argonne National Laboratory on a cryogenic connector for SMES applications. We believe we have a strong patent position in the SMES area, and have also filed a series of patents on our proprietary power electronic modules. We have licensed some of our patents specifically on SMES to third parties.

### ***Trade Secrets***

Some of the important technology used in our operations and products is not covered by any patent or patent application owned by or licensed to us. However, we take steps to maintain the confidentiality of this technology by requiring all employees and all consultants to sign confidentiality agreements and by limiting access to confidential information. However, no assurance can be given that these measures will prevent the unauthorized disclosure or use of that information. In addition, there is no assurance that others, including our competitors, will not independently develop the same or comparable technology that is one of our trade secrets.

### ***Employees***

As of December 31, 2004, we employed a total of 264 persons, 27 of whom have a Ph.D. in materials science, physics or related fields. None of our employees is represented by a labor union. Retaining our key employees is important for achieving our goals and we are committed to developing a working environment that motivates and rewards our employees. At the present time, we believe that we have good relations with our employees.

### ***Properties***

We operate out of two facilities in Westborough, Massachusetts with a combined total of approximately 129,000 square feet of space. The Two Technology Drive facility in Westborough, which houses our 2G development efforts and corporate personnel, is under a lease that expires on May 31, 2009. The 121 Flanders Road facility, which is used by our SuperMachines business unit, is under a lease that expires on September 30, 2006.

On December 7, 2001, we completed construction and took occupancy of a company-owned 355,000-square-foot HTS wire manufacturing facility located at the Devens Commerce Center in Devens, Massachusetts.

Our Power Electronic Systems business unit operates out of facilities located in Middleton and New Berlin, Wisconsin with a combined total of approximately 83,000 square feet of space. The Middleton, Wisconsin facility comprises approximately 33,000 square feet of space in a building with a lease that expires on December 31, 2006. The New Berlin, Wisconsin facility comprises approximately 50,000 square feet of space under a lease that expires on September 30, 2011.

### ***Legal Proceedings***

We received notice on November 5, 2003 of a lawsuit filed against us on October 28, 2003 in the Court of Chancery of the State of Delaware in and for New Castle County by TM Capital Corp., a past financial advisor to us, under which TM Capital claims to be entitled to cash and equity compensation with respect to our October 2003 public equity offering. Specifically, TM Capital is requesting a cash payment in excess of \$1.6 million and warrants to purchase over 170,000 shares of our common stock at an exercise price of \$9.50 per share as a result of our decision not to continue to pursue a proposed \$50 million secured debt transaction and instead complete a public stock offering. We filed an answer to this lawsuit, denying TM Capital's claims for damages and other relief and asserting several counterclaims against TM Capital, including breach of contract, gross negligence, and breach of fiduciary duty. The lawsuit is currently in the process of completing the discovery phase. We believe we have meritorious defenses to this lawsuit and intend to defend it vigorously.

Except as discussed above, we are not involved in any legal proceedings other than routine litigation or related proceedings incidental to our business that we do not consider material.

## MANAGEMENT

The following table lists our directors and executive officers and their ages as of December 31, 2004:

<u>Name</u>	<u>Age</u>	<u>Position</u>
Gregory J. Yurek	57	Chairman of the Board and Chief Executive Officer
David Paratore	36	President and Chief Operating Officer
Kevin M. Bisson	43	Senior Vice President, Chief Financial Officer and Treasurer
Alexis P. Malozemoff	60	Executive Vice President and Chief Technical Officer
Stuart C. Karon	58	Vice President, Business Development
Thomas M. Rosa	51	Vice President, Finance and Accounting and Secretary
Albert J. Baciocco, Jr.	73	Director
Vikram S. Budhraj	57	Director
Peter O. Crisp	72	Director
Richard Drouin	72	Director
Andrew G.C. Sage, II	78	Director
John B. Vander Sande	60	Director

*Gregory J. Yurek* co-founded American Superconductor in 1987 and has been chief executive officer since March 1989 and chairman of the board of directors since October 1991. Dr. Yurek served as president from March 1989 to February 2004, and as vice president and chief technical officer from August 1988 until March 1989. Dr. Yurek also served as chief operating officer from March 1989 until December 1989. Prior to joining American Superconductor, Dr. Yurek was a professor of Materials Science and Engineering at MIT for 12 years. Dr. Yurek has been a director of American Superconductor since 1987.

*David Paratore* joined American Superconductor in November 2000 as vice president, strategic business development. From December 2000 to November 2001, Mr. Paratore ran the company's new Integrated Electronics business in Milwaukee, a business that was later integrated into AMSC's Power Electronic Systems business in March 2002. In November 2001, Mr. Paratore was appointed to the position of vice president and general manager of the SuperMachines Business Unit. In June 2003, Mr. Paratore was appointed senior vice president and general manager of the AMSC Wires Business Unit. In February 2004, Mr. Paratore was appointed president and chief operating officer. In 2000, Mr. Paratore was an account executive for GROWTTH<sup>®</sup> Consulting, an operations management consulting firm.

*Kevin M. Bisson* joined American Superconductor in May 2003 as senior vice president and chief financial officer and was appointed Treasurer in January 2004. Prior to joining American Superconductor, Mr. Bisson was vice president, controller and treasurer for Axcelis Technologies, Inc., a semiconductor equipment manufacturing company, from 2000 to 2003. From 1989 to 2000, Mr. Bisson held several senior financial positions with Hamilton Sundstrand, Hamilton Standard and Carrier Corporation, all units of United Technologies Corporation, a multi-national conglomerate.

*Alexis P. Malozemoff* joined American Superconductor as vice president, research and development in January 1991 and was elected our chief technical officer in January 1993 and senior vice president in May 1998. In May 2003, Dr. Malozemoff was appointed executive vice president in addition to retaining the position of chief technical officer. Prior to joining American Superconductor, Dr. Malozemoff spent 19 years at IBM in a variety of research and management positions, most recently as IBM's research coordinator for high temperature superconductivity.

*Stuart C. Karon* was promoted to his current position of vice president of business development in January 2004. Prior to this, Mr. Karon was director of government programs from June 1998 until January 2004, and director and then vice president of business development of the SuperMachines business unit from June 1999 until January 2004. Prior to joining American Superconductor, Mr. Karon served as a business unit manager and

## [Table of Contents](#)

sales executive at Spectronic Instruments in Rochester, NY. Mr. Karon also completed a 26-year U.S. Navy career in 1994, during which time he served in a series of positions of increasing responsibility, including command of a guided missile destroyer in the Persian Gulf.

*Thomas M. Rosa* joined American Superconductor in October 1992 as corporate controller and was named to the position of chief accounting officer and assistant secretary in July 1998. In May 2003, Mr. Rosa was appointed vice president of finance and accounting. In July 2004, he was named secretary. Prior to joining American Superconductor, Mr. Rosa spent ten years in a variety of financial management positions at Wang Laboratories, Lockheed Sanders and most recently was the division controller at Prime Computer.

*Albert J. Baciocco, Jr.* has been president of The Baciocco Group, Inc., a technical and management consulting practice in strategic planning, technology investment and implementation, since 1987. Preceding this, he served in the U.S. Navy for 34 years, principally within the nuclear submarine force and directing the Department of the Navy research and technology development enterprise, achieving the rank of Vice Admiral. Admiral Baciocco serves on several boards and committees of government, industry and academe. During the past 16 years, he has served as a director of several public corporations and currently serves as a director of several private companies. He is also a trustee of the South Carolina Research Authority and a director of the Foundation for Research Development of the Medical University of South Carolina. Admiral Baciocco has been a director of the Company since April 1997.

*Vikram S. Budhraj* has been president of Electric Power Group, LLC, a Pasadena, California-based consulting firm that provides management and strategic consulting services to the electric power industry since January 2000. From 1977 to January 2000, Mr. Budhraj served in several key senior management positions at Edison International, the parent company of Southern California Edison, including: president of Edison Technology Solutions; senior vice president and head of the Power Grid Business Unit of Southern California Edison; and vice president of System Planning, Fuels and Operations of Southern California Edison. He chairs the Consortium for Electric Reliability Technology Solutions (CERTS) and worked with the U.S.-Canadian Power Systems Outage Task Force that was formed to investigate the root causes of the August 14, 2003 power blackout in the Northeast. Mr. Budhraj has served as a director of Soft Switching Technologies since 2000. Mr. Budhraj has been a director of the Company since March 2004.

*Peter O. Crisp* served as vice chairman of Rockefeller Financial Services, Inc. from December 1997 until September 2003 and is currently a consultant. From 1969 to 1997, he was a general partner of Venrock Associates, a venture capital firm based in New York. Mr. Crisp is also a director of several private companies. Mr. Crisp has been a director of the Company since 1987.

*Richard Drouin* has been chairman of Stelco Inc., a steel manufacturer, and Abitibi Consolidated, the world's largest newsprint manufacturer, since 2000. Mr. Drouin was a partner at McCarthy Tétrault, a Canadian law firm, from December 1995 until December 2003. Mr. Drouin was the chairman and chief executive officer of Hydro-Quebec, a public electric utility based in Canada, from April 1988 to September 1995. Mr. Drouin is a director of Nstein Technologies and chairman of the Board of Trustees of the North American Electric Reliability Council. Mr. Drouin has been a director of the Company since February 1996.

*Andrew G.C. Sage, II* has been president of Sage Capital Corporation since 1974. Immediately prior to that time, he served as president of the investment banking firm of Lehman Brothers. Presently, Mr. Sage is chairman of Robertson Ceco Corporation, a prefabricated metal buildings company, and a director of Tom's Foods, Inc. Throughout his career, Mr. Sage has served in board and executive positions for numerous public companies. Mr. Sage has been a director of the Company since April 1997.

*John B. Vander Sande* co-founded the Company. He has been at MIT since 1971, where he is currently the Cecil and Ida Green Distinguished Professor of Material Science. He was associate dean and acting dean of engineering at MIT from 1992 to 1999 and founding executive director of the Cambridge-MIT Institute from 1999 to January 2003. Dr. Vander Sande has been a director of the Company since 1990.



## DESCRIPTION OF CAPITAL STOCK

### Common Stock

Our authorized capital stock consists of 100,000,000 shares of common stock, \$.01 par value per share. Holders of our common stock are entitled to one vote for each share held on all matters submitted to a vote of stockholders and do not have cumulative voting rights. Accordingly, holders of a plurality of the outstanding shares of our common stock entitled to vote in any election of directors may elect all of the directors standing for election. Holders of our common stock are entitled to receive ratably such dividends, if any, as may be declared by our Board of Directors out of funds legally available therefor. Upon our liquidation, dissolution or winding-up, holders of our common stock are entitled to receive ratably our net assets available for distribution after the payment of all our debts and other liabilities. Holders of our common stock have no preemptive, subscription, redemption or conversion rights.

### Rights Plan

In October 1998, we adopted a Rights Plan. Under the Rights Plan, we distributed one common stock purchase right as a dividend on each outstanding share of our common stock. The rights will expire on October 30, 2008, unless the rights are redeemed or exchanged before that time. Each right entitles the holder to purchase one share of our common stock at an exercise price of \$60.00 per right, subject to adjustment.

The rights will be exercisable only if a person or group has acquired beneficial ownership of 15 percent or more of the outstanding shares of our common stock or commences a tender or exchange offer that would result in that person or group owning 15 percent or more of the outstanding shares of our common stock. If any person or group becomes the beneficial owner of 15 percent or more of the shares of our common stock, except in a tender or exchange offer for all shares at a fair price as determined by the outside members of our Board of Directors, each right not owned by the 15 percent stockholder will entitle its holder to purchase that number of shares of our common stock which equals the exercise price of the right divided by one-half of the market price of our common stock at the date of the occurrence of the event. In addition, if we are involved in a merger or other business combination transaction with another entity in which we are not the surviving corporation or in which our common stock is changed or converted, or if we sell or transfer 50 percent or more of our assets or earning power to another entity, each right will entitle its holder to purchase that number of shares of common stock of that other entity which equals the exercise price of the right divided by one-half of the market price of that common stock at the date of the occurrence of the event. We will generally be entitled to redeem the rights at \$.001 per right at any time until the tenth business day following public announcement that a 15 percent stock position has been acquired and in specified other circumstances.

The rights have certain anti-takeover effects. The rights may cause substantial dilution to a person or entity that attempts to acquire us on terms not approved by our Board of Directors, except under the terms of an offer conditioned on a substantial number of rights being acquired. The rights should not interfere with any merger or other business combination approved by our Board of Directors since we may redeem the rights at \$.001 per right.

### Delaware Anti-Takeover Law

We are subject to the provisions of Section 203 of the General Corporation Law of Delaware. In general, Section 203 prohibits a publicly-held Delaware corporation from engaging in a "business combination" with an "interested stockholder" for a period of three years after the date of the transaction in which the person became an interested stockholder, unless the business combination is approved in a prescribed manner or unless the interested stockholder acquired at least 85 percent of the corporation's voting stock (excluding shares held by designated stockholders) in the transaction in which it became an interested stockholder. A "business combination" includes mergers, assets sales and other transactions resulting in a financial benefit to the interested stockholder. In general, an "interested stockholder" is a person who, together with affiliates and associates, owns, or within the previous three years did own, 15 percent or more of the corporation's voting stock.

**Director and Officer Protection**

Our certificate of incorporation and by-laws contain provisions which provide for the indemnification and limitation of liability of directors and officers. Our by-laws provide that, in general, we shall indemnify each of our directors and officers against liabilities incurred by reason of the fact that such person was a director or officer of American Superconductor if such director or officer acted in good faith and in a manner he reasonably believed to be in or not opposed to the best interests of American Superconductor. Our certificate of incorporation also provides that our directors may not be held personally liable to American Superconductor or our stockholders for monetary damages for a breach of fiduciary duty, except in specified circumstances involving wrongful acts, such as the breach of a director's duty of loyalty or acts of omission not in good faith or which involve intentional misconduct or a knowing violation of law. However, such limitation of liability would not apply to violations of the federal securities laws, nor does it limit the availability of nonmonetary relief in any action or proceeding against a director.

**Transfer Agent**

The transfer agent for our common stock is American Stock Transfer & Trust Company.

**UNDERWRITING**

We have entered into an underwriting agreement with the underwriters named below. Needham & Company, Inc., William Blair & Company, L.L.C., and RBC Capital Markets Corporation are acting as representatives of the underwriters. The underwriters' obligations are several, which means that each underwriter is required to purchase a specific number of shares, but is not responsible for the commitment of any other underwriter to purchase shares. Subject to the terms and conditions of the underwriting agreement, each underwriter has severally agreed to purchase from us the number of shares opposite its name below.

<u>Underwriter</u>	<u>Number of Shares</u>
Needham & Company, Inc.	
William Blair & Company, L.L.C.	
RBC Capital Markets Corporation	
<b>Total</b>	<b>4,000,000</b>

The representatives have advised us that the underwriters propose to offer the shares of common stock to the public at the public offering price per share set forth on the cover page of this prospectus. The underwriters may offer shares to securities dealers, who may include the underwriters, at that public offering price less a concession of up to \$ \_\_\_\_\_ per share. The underwriters may allow, and those dealers may reallow, a concession to other securities dealers of up to \$ \_\_\_\_\_ per share. After the offering to the public, the offering price and other selling terms may be changed by the representatives.

We have granted an option to the underwriters to purchase up to 600,000 additional shares of common stock at the public offering price per share, less the underwriting discounts and commissions, set forth on the cover page of this prospectus. This option is exercisable during the 30-day period after the date of this prospectus. The underwriters may exercise this option only to cover over-allotments made in connection with this offering. If this option is exercised, each of the underwriters will purchase approximately the same percentage of the additional shares as the number of shares of common stock to be purchased by that underwriter, as shown in the table above, bears to the total shown.

The underwriting discount is equal to the public offering price per share of common stock less the amount paid by the underwriters to us per share of common stock. The underwriting discount is \_\_\_\_\_ % of the public offering price. The following table shows the per share and total underwriting discount to be paid to the underwriters by us. These amounts are shown assuming both no exercise and full exercise of the underwriters' option to purchase additional shares.

	<u>Total</u>		
	<u>Per Share</u>	<u>No Exercise</u>	<u>Full Exercise</u>
Paid by American Superconductor			

We estimate that the total expenses of the offering, excluding the underwriting discount and commissions, will be approximately \$ \_\_\_\_\_.

The underwriting agreement provides that we will indemnify the underwriters against certain liabilities that may be incurred in connection with this offering, including liabilities under the Securities Act, or to contribute payments that the underwriters may be required to make in respect thereof.

We have agreed not to offer, sell, contract to sell, grant options to purchase, or otherwise dispose of any shares of our common stock or securities exchangeable for or convertible into our common stock for a period of 90 days after the date of this prospectus without the prior consent of Needham & Company, Inc. This agreement does not apply to any existing employee benefit plans or upon conversion of outstanding securities. Our directors and executive officers have agreed not to, directly or indirectly, sell, hedge, or otherwise dispose of any shares of

## [Table of Contents](#)

common stock, options to acquire shares of common stock, or securities exchangeable for or convertible into shares of common stock, for a period of 90 days after the date of this prospectus without the prior written consent of Needham & Company, Inc.; provided that sales under existing Rule 10b5-1 plans may continue and sales of vesting restricted stock are permitted to cover certain tax obligations of the holders thereof. Needham & Company, Inc. may, in its sole discretion and at any time without notice, release all or any portion of the securities subject to these lock-up agreements.

In connection with this offering, the underwriters may engage in transactions that stabilize, maintain, or otherwise affect the price of our common stock. Specifically, the underwriters may over-allot in connection with this offering by selling more shares than are set forth on the cover page of this prospectus. This creates a short position in our common stock for their own account. The short position may be either a covered short position or a naked short position. In a covered short position, the number of shares over-allotted by the underwriters is not greater than the number of shares that they may purchase in the over-allotment option. In a naked short position, the number of shares involved is greater than the number of shares in the over-allotment option. To close out a short position or to stabilize the price of our common stock, the underwriters may bid for, and purchase, common stock in the open market. The underwriters may also elect to reduce any short position by exercising all or part of the over-allotment option. In determining the source of shares to close out the short position, the underwriters will consider, among other things, the price of shares available for purchase in the open market as compared to the price at which they may purchase shares through the over-allotment option. If the underwriters sell more shares than could be covered by the over-allotment option, a naked short position, the position can only be closed out by buying shares in the open market. A naked short position is more likely to be created if the underwriters are concerned that there could be downward pressure on the price of the shares in the open market after pricing that could adversely affect investors who purchase in the offering.

The underwriters may also impose a penalty bid. This occurs when a particular underwriter or dealer repays selling concessions allowed to it for distributing our common stock in this offering because the underwriters repurchase that stock in stabilizing or short covering transactions.

Finally, the underwriters may bid for, and purchase, shares of our common stock in market making transactions. These activities may stabilize or maintain the market price of our common stock at a price that is higher than the price that might otherwise exist in the absence of these activities. The underwriters are not required to engage in these activities, and may discontinue any of these activities at any time without notice. These transactions may be effected on the NASDAQ National Market or otherwise.

## **LEGAL MATTERS**

The validity of the shares of common stock covered by this prospectus will be passed upon for us by Wilmer Cutler Pickering Hale and Dorr LLP, Boston, Massachusetts. Certain legal matters will be passed upon for the underwriters by Choate, Hall & Stewart, Boston, Massachusetts.

## **EXPERTS**

Our consolidated financial statements as of March 31, 2004 and March 31, 2003 and for each of the three years in the period ended March 31, 2004 included in this prospectus have been so included in reliance on the report of PricewaterhouseCoopers LLP, independent registered public accounting firm, given on the authority of said firm as experts in auditing and accounting.

## **WHERE YOU CAN FIND MORE INFORMATION**

We are subject to the informational requirements of the Securities Exchange Act of 1934 and file annual, quarterly and special reports, proxy statements and other documents with the SEC. You may read and copy any reports, proxy statements and other documents we file at the SEC's public reference room at 450 Fifth Street, N.W., Washington, D.C. 20549. Please call the SEC at 1-800-SEC-0330 for further information on the public reference rooms. You may also obtain copies of these reports, proxy statements and other documents at the SEC's website, the address of which is <http://www.sec.gov>.

We have filed a registration statement on Form S-3 and related exhibits with the SEC under the Securities Act of 1933. The registration statement contains additional information about us and the shares of common stock covered by this prospectus. You may inspect the registration statement and exhibits without charge and obtain copies from the SEC at the location above or from the SEC's web site.

## INCORPORATION OF CERTAIN DOCUMENTS BY REFERENCE

We are incorporating by reference certain documents we file with the SEC, which means that we can disclose important information to you by referring you to those documents. The information in the documents incorporated by reference is considered to be part of this prospectus. Information in documents that we file with the SEC after the date of this prospectus will automatically update and supersede information in this prospectus. We incorporate by reference the documents listed below and any future filings we may make with the SEC under Section 13(a), 13(c), 14 or 15(d) of the Securities Exchange Act of 1934 after the date of this prospectus and prior to the termination of the offering of the shares of common stock covered hereby.

- Our Annual Report on Form 10-K for the fiscal year ended March 31, 2004, filed with the SEC on June 14, 2004;
- Our Quarterly Report on Form 10-Q for the quarterly period ended June 30, 2004, filed with the SEC on August 9, 2004;
- Our Quarterly Report on Form 10-Q for the quarterly period ended September 30, 2004, filed with the SEC on November 9, 2004;
- Our Current Report on Form 8-K dated October 14, 2004, filed with the SEC on October 15, 2004; and
- The description of our common stock contained in our Registration Statement on Form 8-A filed with the SEC on March 5, 1991, as amended.

A statement contained in a document incorporated by reference into this prospectus shall be deemed to be modified or superceded for purposes of this prospectus to the extent that a statement contained in this prospectus, any prospectus supplement or in any other subsequently filed document which is also incorporated in this prospectus modifies or replaces such statement. Any statements so modified or superceded shall not be deemed, except as so modified or superceded, to constitute a part of this prospectus.

You may request a free copy of any of the documents incorporated by reference into this prospectus by writing or telephoning us at the following address:

American Superconductor Corporation  
Two Technology Drive  
Westborough, MA 01581  
(508) 836-4200

[Table of Contents](#)

**AMERICAN SUPERCONDUCTOR CORPORATION**  
**INDEX TO CONSOLIDATED FINANCIAL STATEMENTS**

**Consolidated Financial Statements for the Fiscal Years Ended March 31, 2004, 2003 and 2002**

<a href="#">Report of Independent Registered Public Accounting Firm</a>	F-2
<a href="#">Consolidated Balance Sheets as of March 31, 2004 and 2003</a>	F-3
<a href="#">Consolidated Statements of Operations for the years ended March 31, 2004, 2003 and 2002</a>	F-4
<a href="#">Consolidated Statements of Cash Flows for the years ended March 31, 2004, 2003 and 2002</a>	F-5
<a href="#">Consolidated Statements of Comprehensive Loss for the years ended March 31, 2004, 2003 and 2002</a>	F-6
<a href="#">Consolidated Statements of Stockholders' Equity for the years ended March 31, 2004, 2003 and 2002</a>	F-7
<a href="#">Notes to Consolidated Financial Statements</a>	F-8

**Consolidated Financial Statements for the Three and Six Months Ended September 30, 2004 and 2003**

<a href="#">Unaudited Consolidated Balance Sheet as of September 30, 2004 and Consolidated Balance Sheet as of March 31, 2004</a>	F-26
<a href="#">Unaudited Consolidated Statements of Operations for the three and six months ended September 30, 2004 and 2003</a>	F-27
<a href="#">Unaudited Consolidated Statements of Comprehensive Loss for the three and six months ended September 30, 2004 and 2003</a>	F-28
<a href="#">Unaudited Consolidated Statements of Cash Flows for the six months ended September 30, 2004 and 2003</a>	F-29
<a href="#">Notes to Unaudited Consolidated Financial Statements</a>	F-30

**REPORT OF INDEPENDENT REGISTERED PUBLIC ACCOUNTING FIRM**

To the Board of Directors and Stockholders of  
American Superconductor Corporation:

In our opinion, the accompanying consolidated balance sheets and the related consolidated statements of operations, comprehensive loss, stockholders' equity and cash flows present fairly, in all material respects, the financial position of American Superconductor Corporation and its subsidiaries at March 31, 2004 and 2003, and the results of their operations and their cash flows for each of the three years in the period ended March 31, 2004 in conformity with accounting principles generally accepted in the United States of America. These financial statements are the responsibility of the Company's management. Our responsibility is to express an opinion on these financial statements based on our audits. We conducted our audits of these statements in accordance with the standards of the Public Company Accounting Oversight Board (United States). Those standards require that we plan and perform the audit to obtain reasonable assurance about whether the financial statements are free of material misstatement. An audit includes examining, on a test basis, evidence supporting the amounts and disclosures in the financial statements, assessing the accounting principles used and significant estimates made by management, and evaluating the overall financial statement presentation. We believe that our audits provide a reasonable basis for our opinion.

/s/ PricewaterhouseCoopers LLP

Boston, Massachusetts  
May 5, 2004



**AMERICAN SUPERCONDUCTOR CORPORATION**  
**CONSOLIDATED BALANCE SHEETS**

	March 31, 2004	March 31, 2003
<b>ASSETS</b>		
Current assets:		
Cash and cash equivalents	\$ 31,241,237	\$ 18,487,752
Short-term marketable securities	15,045,419	—
Accounts receivable, net	8,566,657	5,446,007
Inventory	4,889,394	5,117,786
Prepaid expenses and other current assets	906,956	1,264,839
Total current assets	60,649,663	30,316,384
Property, plant and equipment:		
Land	4,021,611	4,021,611
Construction in progress—building and equipment	1,506,326	8,773,458
Building	34,102,138	34,102,138
Equipment	40,645,778	31,966,730
Furniture and fixtures	4,168,165	4,167,345
Leasehold improvements	6,269,037	6,246,497
	90,713,055	89,277,779
Less: accumulated depreciation	(34,082,036)	(28,241,982)
Property, plant and equipment, net	56,631,019	61,035,797
Long-term marketable securities	6,360,047	1,561,120
Long-term inventory	—	3,250,000
Goodwill	1,107,735	1,107,735
Other assets	5,150,492	4,707,603
Total assets	\$ 129,898,956	\$ 101,978,639
<b>LIABILITIES AND STOCKHOLDERS' EQUITY</b>		
Current liabilities:		
Accounts payable and accrued expenses	\$ 11,541,634	\$ 9,773,874
Deferred revenue	2,905,792	1,136,002
Total current liabilities	14,447,426	10,909,876
Long-term deferred revenue	—	3,250,000
Commitments and contingencies (Note 11)		
Stockholders' equity:		
Common stock, \$.01 par value		
Authorized shares—50,000,000; shares issued and outstanding 27,614,149 and 21,293,772 at March 31, 2004 and March 31, 2003, respectively	276,141	212,938
Additional paid-in capital	415,729,441	361,024,689
Deferred compensation	(701,524)	(311,563)
Accumulated other comprehensive income (loss)	(9,337)	2,407
Accumulated deficit	(299,843,191)	(273,109,708)
Total stockholders' equity	115,451,530	87,818,763
Total liabilities and stockholders' equity	\$ 129,898,956	\$ 101,978,639

The accompanying notes are an integral part of the consolidated financial statements.

**AMERICAN SUPERCONDUCTOR CORPORATION**  
**CONSOLIDATED STATEMENTS OF OPERATIONS**

	Year ended March 31,		
	2004	2003	2002
<b>Revenues:</b>			
Contract revenue	\$ 874,735	\$ 715,109	\$ 2,111,460
Product sales and prototype development contracts	40,433,970	20,305,183	9,538,640
<b>Total revenues</b>	<b>41,308,705</b>	<b>21,020,292</b>	<b>11,650,100</b>
<b>Costs and expenses:</b>			
Costs of revenue—contract revenue	825,223	684,341	2,100,789
Costs of revenue—product sales and prototype development contracts	43,454,971	31,517,605	17,298,856
Research and development	14,056,035	21,940,369	27,814,044
Selling, general and administrative	8,658,750	16,158,585	16,313,306
Pirelli license costs	—	—	4,009,890
Restructuring charges	—	—	5,666,059
Impairment charge	—	39,230,877	—
<b>Total costs and expenses</b>	<b>66,994,979</b>	<b>109,531,777</b>	<b>73,202,944</b>
Operating loss	(25,686,274)	(88,511,485)	(61,552,844)
Interest income	295,656	868,648	4,450,769
Fees—abandoned debt financing	(1,387,857)	—	—
Other income (expense), net	44,992	9,910	117,186
<b>Net loss</b>	<b>\$ (26,733,483)</b>	<b>\$ (87,632,927)</b>	<b>\$ (56,984,889)</b>
<b>Net loss per common share</b>			
Basic and Diluted	\$ (1.10)	\$ (4.21)	\$ (2.79)
<b>Weighted average number of common shares outstanding</b>			
Basic and Diluted	24,196,077	20,830,846	20,409,233

The accompanying notes are an integral part of the consolidated financial statements.

**AMERICAN SUPERCONDUCTOR CORPORATION**  
**CONSOLIDATED STATEMENTS OF CASH FLOWS**

	Year ended March 31,		
	2004	2003	2002
<b>Cash flows from operating activities:</b>			
Net loss	\$ (26,733,483)	\$ (87,632,927)	\$ (56,984,889)
<b>Adjustments to reconcile net loss to net cash used in operations:</b>			
Depreciation and amortization	7,289,225	8,102,136	5,509,043
Impairment charge	—	39,230,877	—
Allowance for doubtful accounts	—	2,624,010	727,028
Inventory write-down charges	—	3,421,100	3,464,275
Loss on disposal of PP&E and abandoned patents	128,163	875,123	—
Restructuring charges (non-cash portion)	—	—	2,929,741
Pirelli license payment (non-cash portion)	—	—	1,720,500
IRL license payment	202,950	—	—
Amortization of deferred compensation expense	262,078	14,777	106,067
Amortization of deferred warrant costs	53,290	174,457	268,470
Stock compensation expense	358,607	367,192	479,472
<b>Changes in operating asset and liability accounts :</b>			
Accounts receivable	(3,120,650)	(486,512)	4,947,670
Inventory-current and long-term	3,478,392	5,360,285	(2,376,178)
Prepaid expenses and other current assets	371,925	(532,114)	(167,801)
Accounts payable and accrued expenses	1,767,760	(10,665,557)	11,863,409
Deferred revenue—current and long-term	(1,480,210)	(457,804)	1,056,806
<b>Net cash used in operating activities</b>	<b>(17,421,953)</b>	<b>(39,604,957)</b>	<b>(26,456,387)</b>
<b>Cash flows from investing activities:</b>			
Purchase of property, plant and equipment	(1,957,208)	(7,799,235)	(63,122,176)
Proceeds from the sale of property, plant and equipment	115,235	—	—
Purchase of long-term marketable securities	(21,239,246)	(770,000)	—
Proceeds from the sale of long-term marketable securities	1,369,686	30,119,683	39,452,114
Increase in other assets	(1,614,098)	(992,457)	(3,173,100)
<b>Net cash (used in) provided by investing activities</b>	<b>(23,325,631)</b>	<b>20,557,991</b>	<b>(26,843,162)</b>
<b>Cash flows from financing activities:</b>			
Net proceeds from secondary public offering	50,649,030	—	—
Net proceeds from issuance of common stock	2,852,039	363,791	1,407,177
<b>Net cash provided by financing activities</b>	<b>53,501,069</b>	<b>363,791</b>	<b>1,407,177</b>
<b>Net increase (decrease) in cash and cash equivalents</b>	<b>12,753,485</b>	<b>(18,683,175)</b>	<b>(51,892,372)</b>
Cash and cash equivalents at beginning of period	18,487,752	37,170,927	89,063,299
<b>Cash and cash equivalents at end of period</b>	<b>\$ 31,241,237</b>	<b>\$ 18,487,752</b>	<b>\$ 37,170,927</b>
<b>Supplemental schedule of cash flow information:</b>			
Noncash purchase of NST Inventory	\$ —	\$ 149,340	\$ —
Noncash purchase of NST Property, Plant & Equipment	—	1,763,680	—
Noncash purchase of NST Patent assets	—	200,000	—
<b>Noncash issuance of common stock-NKT Holding</b>	<b>\$ —</b>	<b>\$ 2,113,020</b>	<b>\$ —</b>
<b>Noncash issuance of common stock</b>	<b>\$ 823,635</b>	<b>\$ 727,469</b>	<b>\$ 585,539</b>

The accompanying notes are an integral part of the consolidated financial statements.

**AMERICAN SUPERCONDUCTOR CORPORATION**  
**CONSOLIDATED STATEMENTS OF COMPREHENSIVE LOSS**

	Year ended March 31,		
	2004	2003	2002
Net loss	\$ (26,733,483)	\$ (87,632,927)	\$ (56,984,889)
Other comprehensive income (loss)			
Foreign currency translation	13,469	24,646	7,007
Unrealized gains (losses) on investments	(25,213)	(117,880)	(681,007)
Other comprehensive income (loss)	(11,744)	(93,234)	(674,000)
Comprehensive income (loss)	\$ (26,745,227)	\$ (87,726,161)	\$ (57,658,889)

The accompanying notes are an integral part of the consolidated financial statements.

**AMERICAN SUPERCONDUCTOR CORPORATION**  
**CONSOLIDATED STATEMENTS OF STOCKHOLDERS' EQUITY**

	Common Stock		Additional Paid-in Capital	Deferred Compensation	Deferred Contract Costs	Other Comprehensive Income (Loss)	Accumulated Deficit	Total Stockholders' Equity
	Number of Shares	Par Value						
Balance at March 31, 2001	20,290,596	\$202,906	\$355,843,848	\$ (424,266)	\$(336,347)	\$ 769,641	\$(128,491,892)	\$ 227,563,890
Exercise of stock options	75,166	752	708,748					709,500
Issuance of common stock—ESPP	96,720	967	696,710					697,677
Amortization of deferred compensation				106,067				106,067
Stock compensation expense	35,032	350	479,122					479,472
Amortization of deferred warrant costs			53,290		215,180			268,470
Unrealized loss on investments						(681,007)		(681,007)
Cumulative translation adjustment						7,007		7,007
Net loss							(56,984,889)	(56,984,889)
Balance at March 31, 2002	20,497,514	\$204,975	\$357,781,718	\$ (318,199)	\$(121,167)	\$ 95,641	\$(185,476,781)	\$ 172,166,187
Issuance of common stock—ESPP	88,881	889	362,902					363,791
Purchase of NST	546,000	5,460	2,107,560					2,113,020
Issuance of common stock to Pirelli	50,000	500	345,000					345,500
Deferred Compensation	30,000	300	7,841	(8,141)				0
Amortization of deferred compensation				14,777				14,777
Stock compensation expense	81,377	814	366,378					367,192
Amortization of deferred warrant costs			53,290		121,167			174,457
Unrealized loss on investments						(117,880)		(117,880)
Cumulative translation adjustment						24,646		24,646
Net loss							(87,632,927)	(87,632,927)
Balance at March 31, 2003	21,293,772	\$212,938	\$361,024,689	\$ (311,563)	\$ —	\$ 2,407	\$(273,109,708)	\$ 87,818,763
Exercise of stock options	282,010	2,820	2,621,569					2,624,389
Secondary public offering of common stock	5,721,250	57,212	50,591,818					50,649,030
Issuance of common stock—ESPP	90,505	905	226,745					227,650
Issuance of common stock to IRL	15,000	150	202,800					202,950
Deferred Compensation	149,750	1,497	650,542	(652,039)				0
Amortization of deferred compensation				262,078				262,078
Stock compensation expense	61,862	619	357,988					358,607
Amortization of deferred warrant costs			53,290					53,290
Unrealized loss on investments						(25,213)		(25,213)
Cumulative translation adjustment						13,469		13,469
Net loss							(26,733,483)	(26,733,483)
Balance at March 31, 2004	27,614,149	\$276,141	\$415,729,441	\$ (701,524)	\$ —	\$ (9,337)	\$(299,843,191)	\$ 115,451,530

The accompanying notes are an integral part of the consolidated financial statements.

**AMERICAN SUPERCONDUCTOR CORPORATION**  
**NOTES TO CONSOLIDATED STATEMENTS**

**1. Nature of the Business and Operations**

American Superconductor Corporation (the Company or AMSC) was formed on April 9, 1987. The Company is focused on developing, manufacturing and selling products using two core technologies: high temperature superconductor (HTS) wires and power electronic converters for electric power applications. The Company also assembles superconductor wires and power electronic converters into fully-integrated products, such as HTS ship propulsion motors and dynamic reactive compensation systems, which the Company sells or plans to sell to end users. The Company operates in three business segments—AMSC Wires, SuperMachines and Power Electronic Systems.

The Company has generated operating losses since its inception in 1987 and expects to continue incurring losses until at least the end of fiscal 2005. Operating losses for the fiscal years ended March 31, 2004, 2003 and 2002 have contributed to net cash used by operating activities of \$17,421,953, \$39,604,957 and \$26,456,387, respectively, for these periods.

The Company had cash, cash equivalents, and short and long-term marketable securities of \$52,646,703 as of March 31, 2004. To supplement the Company's anticipated cash needs for operations, as well as its investment in the second generation (2G) wire development program, the Company issued 5,721,250 shares of its common stock in a public equity offering in October 2003 that raised \$51,147,975 (after deducting underwriting commissions and discounts but before deducting offering expenses).

The Company currently derives a portion of its revenue from research and development contracts. The Company recorded contract revenue related to research and development contracts of \$874,735, \$715,109 and \$2,111,460 for the fiscal years ended March 31, 2004, 2003, and 2002, respectively. In addition, the Company recorded prototype development contract revenue on U.S. Navy and other contracts of \$27,326,819, \$8,220,348 and \$6,036,591, which are included under "Revenues—Product sales and prototype development contracts," for the fiscal years ended March 31, 2004, 2003 and 2002, respectively.

Costs of revenue include research and development (R&D) and selling, general, and administrative (SG&A) expenses that are incurred in the performance of these development contracts.

R&D and SG&A expenses included as costs of revenue for these development contracts were as follows:

	For the years ended March 31,		
	2004	2003	2002
Research and development expenses	\$ 25,442,000	\$ 10,997,000	\$ 8,757,000
Selling, general and administrative expenses	\$ 7,395,000	\$ 1,482,000	\$ 1,659,000

**2. Summary of Significant Accounting Policies**

A summary of the Company's significant accounting policies follows:

*Basis of Consolidation*

The consolidated financial statements include the accounts of the Company and its wholly-owned subsidiaries. All significant intercompany balances are eliminated. Certain prior year amounts have been reclassified to be consistent with the current year presentation.

*Cash Equivalents*

The Company considers all highly liquid debt instruments with current maturities of three months or less to be cash equivalents. Cash equivalents consist principally of money market accounts and corporate debt instruments.

**AMERICAN SUPERCONDUCTOR CORPORATION**  
**NOTES TO CONSOLIDATED STATEMENTS—(Continued)**

*Short-term Marketable Securities*

Short-term marketable securities, with current maturities of greater than 3 months but less than 12 months, consist primarily of corporate bonds and other debt securities, in accordance with Statement of Financial Accounting Standards (SFAS) No. 115, "Accounting for Certain Investments in Debt and Equity Securities" issued by the Financial Standards Accounting Board (FASB). The Company determines the appropriate classification of its marketable securities at the time of purchase and re-evaluates such classification as of each balance sheet date.

*Accounts Receivable*

Due to scheduled billing requirements specified under certain contracts, a portion of the Company's accounts receivable balance at March 31, 2004 and 2003 was unbilled. The Company expects most of the unbilled balance at March 31, 2004 to be billed by the first quarter of the fiscal year ending March 31, 2005. At March 31, 2004, the Company had two customers that represented approximately 40% and 17% of the total accounts receivable balance. At March 31, 2003, the Company had three customers that represented approximately 48%, 15% and 10% of the total accounts receivable balance.

*Long-term Marketable Securities*

Long-term marketable securities, with current maturities of 12 months or more, consist primarily of corporate bonds and other debt securities, in accordance with SFAS No. 115, "Accounting for Certain Investments in Debt and Equity Securities." The Company determines the appropriate classification of its marketable securities at the time of purchase and re-evaluates such classification as of each balance sheet date.

*Inventories*

Inventories are stated at the lower of cost (determined on a first-in first-out basis) or market.

*Property and Equipment*

The Company accounts for depreciation and amortization using the straight-line method to allocate the cost of property and equipment over their estimated useful lives as follows:

<u>Asset classification</u>	<u>Estimated useful life</u>
Building	40 years
Process upgrades to the building	10-40 years
Machinery and equipment	5-10 years
Furniture and fixtures	3 years
Leasehold improvements	Remaining lease term

Expenditures for maintenance and repairs are expensed as incurred. Upon retirement or other disposition of assets, the costs and related accumulated depreciation are eliminated from the accounts and the resulting gain or loss is reflected in income.

Depreciation expense was \$6,313,238, \$7,098,641 and \$4,888,353 for the fiscal years ended March 31, 2004, 2003, and 2002, respectively.

*Acquisition of Assets*

On October 31, 2002, the Company acquired fixed assets, inventory and patents from Nordic Superconductor Technologies A/S (NST), a subsidiary of NKT Holding A/S, in exchange for 546,000 shares of

**AMERICAN SUPERCONDUCTOR CORPORATION**  
**NOTES TO CONSOLIDATED STATEMENTS—(Continued)**

the Company's common stock valued at \$2,113,020. NKT Holding has agreed to hold these shares for at least two years. NST had developed and marketed HTS wire to customers in Europe, Asia, and North America. The Company did not assume any debt or other liabilities in the transaction. No NST employees were retained by the Company. The assets acquired were fixed assets valued at \$1,763,680, patents valued at \$200,000, and inventory valued at \$149,340.

*Goodwill and Other Intangible Assets*

The Company has intangible assets consisting of goodwill, licenses and patents.

Effective April 1, 2001, the Company adopted the provisions of SFAS No. 142, "Goodwill and Other Intangible Assets," which requires that ratable amortization of goodwill and certain intangibles be replaced with periodic tests of goodwill's impairment and that other intangibles be amortized over their useful lives unless these lives are determined to be indefinite. SFAS No. 142 requires that goodwill be tested annually for impairment under a two-step process or whenever events or changes in circumstances suggest that the carrying value of an asset may not be recoverable. The Company amortizes licenses and patents using the straight-line method over a period up to 7 years.

The Company reviews its goodwill at least annually or when events or changes in circumstances indicate that the carrying amount of such assets may not be fully recoverable. If the carrying amount of the net tangible and intangible assets in a given reporting unit exceeds the reporting unit's fair value, a detailed impairment loss analysis would be performed to calculate the amount of impairment, if any, prescribed by SFAS No. 142. Goodwill of \$1,107,735 at March 31, 2004 and 2003 represents the excess of the purchase price paid for the acquisition of substantially all of the assets of Integrated Electronics, LLC (IE) on June 1, 2000, over the fair value of IE's assets, less amortization. The IE transaction was accounted for under the purchase method of accounting. Goodwill was initially calculated to be \$1,329,282, and was amortized until the adoption of SFAS 142 on April 1, 2001.

Goodwill amortization expense was \$0 in the fiscal years ended March 31, 2004, 2003 and 2002. Accumulated goodwill amortization was \$221,547 at March 31, 2004 and 2003.

*Accounting for Impairment of Long-Lived Assets*

The Company periodically evaluates its long-lived assets for potential impairment under SFAS No. 144, "Accounting for the Impairment or Disposal of Long-Lived Assets." The Company performs these evaluations whenever events or circumstances suggest that the carrying amount of an asset or group of assets is not recoverable. The Company's judgments regarding the existence of impairment indicators are based on market and operational performance. Indicators of potential impairment include:

- a significant change in the manner in which an asset is used;
- a significant decrease in the market value of an asset;
- a significant adverse change in its business or the industry in which it is sold;
- a current period operating cash flow loss combined with a history of operating or cash flow losses or a projection or forecast that demonstrates continuing losses associated with the asset; and
- significant advances in the Company's technologies that require changes in the manufacturing process.



**AMERICAN SUPERCONDUCTOR CORPORATION**  
**NOTES TO CONSOLIDATED STATEMENTS—(Continued)**

If the Company believes an indicator of potential impairment exists, it tests to determine whether impairment recognition criteria in SFAS No. 144 have been met. To analyze a potential impairment, the Company projects undiscounted future cash flows over the remaining life of the asset or the primary asset in the asset group. If these projected cash flows are less than the carrying amount, an impairment loss is recognized based on the fair value of the asset or asset group less any costs of disposition. Evaluating the impairment requires judgment by the Company's management to estimate future operating results and cash flows. If different estimates were used, the amount and timing of asset impairments could be affected. The Company charges impairments of the long-lived assets to operations if its evaluations indicate that the carrying values of these assets are not recoverable.

*Revenue Recognition and Deferred Revenue*

For certain arrangements, such as contracts to perform research and development, prototype development contracts and certain product sales, the Company records revenues using the percentage of completion method, measured by the relationship of costs incurred to total estimated contract costs. The Company follows this method since reasonably dependable estimates of the revenue and costs applicable to various stages of a contract can be made. Since many contracts extend over a long period of time, revisions in cost and funding estimates during the progress of work have the effect of adjusting earnings applicable to prior-period performance in the current period. Recognized revenues and profit or loss are subject to revisions as the contract progresses to completion. Revisions in profit or loss estimates are charged to income in the period in which the facts that give rise to the revision become known. Some of the Company's contracts contain incentive provisions, based upon performance in relation to established targets, which are recognized in the contract estimates when deemed realizable.

The Company recognizes revenue from product sales upon customer acceptance, which can occur at the time of delivery, installation or post-installation, where applicable, provided persuasive evidence of an arrangement exists, delivery has occurred, the sales price is fixed or determinable and collectibility is reasonably assured. When other significant obligations remain after products are delivered, revenue is recognized only after such obligations (including buyback provisions) are fulfilled. Customer deposits received in advance of revenue recognition are recorded as deferred revenue until customer acceptance is received. Deferred revenue also represents the amount billed to and/or collected from commercial and government customers on contracts which permit billings to occur in advance of contract performance/revenue recognition.

For the fiscal year ended March 31, 2004, the Company had two customers that represented approximately 64% and 14% of total revenue, respectively. For the fiscal year ended March 31, 2003, the Company had two customers that represented approximately 39% and 37% of total revenue, respectively. For the fiscal year ended March 31, 2002, the Company had three customers that represented approximately 51%, 14% and 13% of total revenue, respectively.

*Research and Development Costs*

Research and development costs are expensed as incurred.

*Income Taxes*

Deferred income taxes are recognized for the tax consequences in future years of differences between the tax bases of assets and liabilities and their financial reporting amounts at each fiscal year end based on enacted tax laws and statutory tax rates applicable to the periods in which the differences are expected to affect taxable income. Valuation allowances are established when necessary to reduce net deferred tax assets to the amount expected to be realized. No current or deferred income taxes have been provided because of the net operating losses incurred by the Company since its inception.

**AMERICAN SUPERCONDUCTOR CORPORATION**  
**NOTES TO CONSOLIDATED STATEMENTS—(Continued)**

*Stock-Based Compensation Plans and Pro Forma Stock-Based Compensation Expense*

The Company applies Accounting Principles Board Opinion (APB) No. 25, "Accounting for Stock Issued to Employees," and related interpretations in accounting for its stock-based compensation plan. Accordingly, no accounting recognition is given to stock options granted at fair market value until they are exercised. Upon exercise, net proceeds, including tax benefits realized, are credited to stockholders' equity.

In October 1995, the FASB issued SFAS No. 123, "Accounting for Stock-Based Compensation," which sets forth a fair-value-based method of recognizing stock-based compensation expense. As permitted by SFAS No. 123, the Company has elected to continue to apply APB No. 25 to account for its stock-based compensation plan.

Had compensation cost for awards granted under the Company's stock-based compensation plan been determined based on the fair value at the grant dates consistent with the method set forth under SFAS No. 123, the effect on certain financial information of the Company would have been as follows:

	For the fiscal years ended March 31,		
	2004	2003	2002
Net loss	\$(26,733,483)	\$(87,632,927)	\$(56,984,889)
Add: Stock compensation expense under APB 25	262,078	14,777	106,067
Less: Stock compensation costs, net of tax, had all stock options been recorded at fair value per SFAS 123	(4,211,225)	(6,725,805)	(10,096,333)
Adjusted net loss	\$(30,682,630)	\$(94,343,955)	\$(66,975,155)
Weighted average shares, basic and diluted	24,196,077	20,830,846	20,409,233
Net loss per share, as reported	\$ (1.10)	\$ (4.21)	\$ (2.79)
Net loss per share, adjusted	\$ (1.27)	\$ (4.53)	\$ (3.28)

The pro forma amounts include the effects of all activity under the Company's stock-based compensation plans since April 1, 1999. The fair value of each option grant is estimated on the date of grant using the Black-Scholes option pricing model with the following assumptions used for grants:

	Fiscal 2004	Fiscal 2003	Fiscal 2002
Dividend yield	None	None	None
Expected volatility	78%	101%	87%
Risk-free interest rate	3.0%	4.0%	4.5%
Expected life (years)	6.5	6.5	6.8

*Weighted average fair value of options granted at fair market value during:*

Fiscal 2004	\$ 3.87
Fiscal 2003	\$ 6.04
Fiscal 2002	\$10.35

The above amounts may not be indicative of future expense because amounts are recognized over the vesting period and the Company expects it will have additional grants and related activity under these plans in the future.

**AMERICAN SUPERCONDUCTOR CORPORATION**  
**NOTES TO CONSOLIDATED STATEMENTS—(Continued)**

*Computation of Net Loss per Common Share*

Basic earnings per share (EPS) is computed by dividing net income available to common stockholders by the weighted-average number of common shares outstanding for the period. Diluted EPS is computed using the weighted average number of common and dilutive common equivalent shares outstanding during the period. Common equivalent shares include the effect of the exercise of stock options and warrants. For the years ended March 31, 2004, 2003, and 2002, common equivalent shares of 3,165,917, 4,485,201 and 2,537,279, respectively, were not included in the calculation of diluted EPS as they were considered antidilutive.

*Foreign Currency Translation*

The functional currency of the Company's foreign subsidiary is the local currency. The assets and liabilities of this operation are translated into U.S. dollars at the exchange rate in effect at the balance sheet date and income and expense items are translated at average rates for the period. Cumulative translation adjustments are excluded from net loss and shown as a separate component of stockholders' equity. Foreign currency transaction gains and losses are included in the net loss and have not been material to date.

*Risks and Uncertainties*

The preparation of financial statements in conformity with generally accepted accounting principles requires management to make estimates and assumptions that affect the reported amounts of assets and liabilities and disclosures of contingent assets and liabilities at the date of the financial statements and the reported amounts of revenues and expenses during the reporting period. Actual results could differ from those estimates and would impact future results of operations and cash flows.

The Company invests its available cash with high-credit, quality financial institutions and invests primarily in investment grade-marketable securities, including, but not limited to, government obligations, repurchase agreements, money market funds and corporate debt instruments.

The Company's accounts receivable are comprised of amounts owed by government agencies and commercial companies. The Company does not require collateral or other security to support customer receivables.

Several of the Company's government contracts are being funded incrementally, and as such, are subject to the future authorization, appropriation, and availability of government funding. The Company has a history of successful performance under incrementally-funded contracts with the U.S. government and it expects to continue to receive additional contract modifications in fiscal 2005 and beyond as incremental funding is authorized and appropriated by the government.

**3. Short and Long-term Marketable Securities**

Short and long-term marketable securities at March 31, 2004 and 2003 consisted primarily of corporate debt instruments.

	2004	2003
Aggregate cost	\$ 21,420,323	\$ 1,552,249
Fair value	21,405,466	1,561,120
Gross unrealized gain (loss)	\$ (14,857)	\$ 8,871

**AMERICAN SUPERCONDUCTOR CORPORATION**  
**NOTES TO CONSOLIDATED STATEMENTS—(Continued)**

Gross unrealized gains for fiscal 2004 and 2003 were \$6,552 and \$8,871, respectively, and gross unrealized losses for fiscal 2004 and 2003 were \$21,409 and \$0, respectively. The Company's short and long-term marketable securities are classified as available-for-sale securities and, accordingly, are recorded at amortized cost plus accrued interest which approximates fair value. The difference between cost and fair value is included in stockholders' equity. The portion of the marketable securities due to mature within one year is \$15,045,419 and the remaining \$6,360,047 is due to mature between one year and 18 months.

**4. Accounts Receivable**

Accounts receivable at March 31, 2004 and 2003 consisted of the following:

	2004	2003
Accounts receivable (billed)	\$3,427,482	\$ 4,828,214
Accounts receivable (unbilled)	5,180,524	3,275,278
Less: Allowance for doubtful accounts	(41,349)	(2,657,485)
Net accounts receivable	<u>\$8,566,657</u>	<u>\$ 5,446,007</u>

The Company recorded a \$41,349 and \$2,650,398 allowance for doubtful accounts provision in fiscal 2004 and 2003, respectively. These are shown as part of selling, general and administrative expense. A \$2,624,010 receivable was written off in fiscal 2004 against the allowance for doubtful accounts, as were other miscellaneous receivables of \$33,475, which were also reserved for in prior years.

**5. Inventories**

Inventories at March 31, 2004 and 2003 consisted of the following:

	2004	2003
Raw materials	\$ 623,792	\$ 1,217,033
Work-in-progress	2,109,794	2,250,321
Finished goods	2,155,808	1,650,432
	<u>\$ 4,889,394</u>	<u>\$ 5,117,786</u>

The Company recorded a charge of \$3,421,100 in fiscal 2003 relating to the write-down of the remaining inventory value of low temperature superconductor storage devices. This inventory reserve provision was recorded as part of Costs of revenue—product sales and prototype development contracts.

Finished goods inventory includes the cost of products shipped to customers on contracts on which revenue will be deferred until final customer acceptance.

The Company also had long-term inventory as of March 31, 2003. See Note 7.

**6. Other Assets**

Other assets at March 31, 2004 and 2003 consisted of the following:

	2004	2003
Licenses	\$ 1,953,247	\$ 1,053,248
Patents	6,072,406	5,725,055
Deposits	58,535	56,962
	<u>8,084,188</u>	<u>6,835,265</u>
Less: accumulated amortization		
Licenses	(861,580)	(693,724)
Patents	(2,072,116)	(1,433,938)
Other assets	<u>\$ 5,150,492</u>	<u>\$ 4,707,603</u>

**AMERICAN SUPERCONDUCTOR CORPORATION**  
**NOTES TO CONSOLIDATED STATEMENTS—(Continued)**

The Company recorded patent and license amortization expense of \$975,987, \$1,003,495 and \$620,690 for fiscal years 2004, 2003, and 2002, respectively. Abandoned licenses were \$0 and \$95,000 in fiscal 2004 and 2003, respectively, and abandoned patents were \$365,174 and \$812,529 in fiscal 2004 and 2003, respectively. The accumulated amortization on these abandonments was \$169,951 and \$320,645 for fiscal 2004 and 2003, respectively, resulting in a net abandonment-related change in Other assets of \$195,223 and \$586,884 for fiscal 2004 and 2003, respectively.

Amortization expense for the next five years consists of the following:

	For the fiscal years ended March 31,					Total
	2005	2006	2007	2008	2009	
Licenses	\$ 230,357	\$ 206,548	\$ 187,798	\$ 143,155	\$ 132,738	\$ 900,595
Patents	849,258	827,193	784,703	737,481	474,639	3,673,274
	\$ 1,079,615	\$ 1,033,741	\$ 972,501	\$ 880,636	\$ 607,377	\$ 4,573,869

**7. Long-term Inventory and Deferred Revenue**

Long-term inventory and long-term deferred revenue decreased from \$3,250,000 as of March 31, 2003 to \$0 as of March 31, 2004 due to the unconditional sale of six distributed superconducting magnetic energy storage (D-SMES) units to American Transmission Company (ATC) in December 2003. These six D-SMES units were originally delivered in fiscal 2001 to another one of the Company's customers, Wisconsin Public Service Corporation (WPS), for a total purchase price of \$3,787,000. As the sale of these units to WPS was originally subject to certain return and buyback provisions that expired from 2002 to 2009, the Company deferred recognition of the revenue related to the original sale until the applicable buyback provisions lapsed. The buyback provisions, which were subject to a minimum 6-month written notice requirement, began to lapse in the quarter ended December 31, 2002, until which time WPS had the right to return all the units for the full purchase price of \$3,787,000. The Company recorded \$537,000 of revenue and an equal amount of cost of revenue in the quarter ended December 31, 2002, as the buyback price was reduced from \$3,787,000 to \$3,250,000. In December 2003, WPS exercised its buyback provision for the remaining \$3,250,000 price as part of an agreement whereby ATC unconditionally purchased the six D-SMES units. ATC's purchase of the D-SMES units was a follow-up to its purchase of substantially all of the transmission assets of WPS in January 2001 and a lengthy performance evaluation of the units. As a result, the Company recorded \$3,250,000 of revenue and an equal amount of cost of revenue on its consolidated statement of operations for the quarter ended December 31, 2003. The Company also recorded a \$3,250,000 reduction in long-term inventory and long-term deferred revenue on its consolidated balance sheet as of December 31, 2003.

**8. Accounts Payable and Accrued Expenses**

Accounts payable and accrued expenses at March 31, 2004 and 2003 consisted of the following:

	2004	2003
Accounts payable	\$ 4,408,212	\$ 3,721,307
Accrued restructuring	119,493	435,317
Accrued employee stock purchase plan	189,659	199,567
Accrued expenses	6,100,914	4,749,327
Accrued vacation	723,356	668,356
	\$ 11,541,634	\$ 9,773,874

**AMERICAN SUPERCONDUCTOR CORPORATION**  
**NOTES TO CONSOLIDATED STATEMENTS—(Continued)**

**9. Income Taxes**

The reconciliation between the statutory federal income tax rate and the Company's effective income tax rate is shown below.

	For the Years Ended March 31,		
	2004	2003	2002
Statutory federal income tax rate	-34%	-34%	-34%
State income taxes, net federal benefit	-7%	-6%	-7%
Nondeductible expenses	0%	0%	1%
Research & development credit	-1%	0%	-2%
Valuation allowance	42%	40%	42%
	0%	0%	0%
Effective income tax rate	0%	0%	0%

The principal components of the Company's deferred tax liabilities and assets were the following:

	For the Years Ended March 31,	
	2004	2003
<b>Deferred tax assets and (liabilities):</b>		
Net operating loss carryforward	\$ 106,789,000	\$ 93,547,000
Research and development and other credits	6,065,000	3,583,000
Accruals and reserves	4,239,000	4,146,000
Fixed Assets and intangibles	14,611,000	17,475,000
Other	411,000	302,000
Valuation allowance	(132,115,000)	(119,053,000)
	\$ —	\$ —
Net	\$ —	\$ —

At March 31, 2004 the Company had available for federal income tax purposes net operating loss carryforwards of approximately \$276,200,000, which expire in years 2005 through 2024. This includes approximately \$14,700,000 of acquired net operating losses from Superconductivity, Inc. (SI) which begin to expire in the fiscal year ending 2005 through 2012, and their utilization by the Company will be subject to annual limitations. SI was acquired by the Company on April 8, 1997 through the merger of a wholly-owned subsidiary of the Company into SI.

The Company has recorded a deferred tax asset of approximately \$13,469,000 reflecting the benefit of deductions from the exercise of stock options. This deferred tax asset has been fully reserved since it is more likely than not that the tax benefit from the exercise of stock options will not be realized. The benefit from this \$13,469,000 will be recorded as a credit to additional paid-in capital if realized. Research and development and other credit carryforwards amounting to approximately \$7,600,000 are available to offset federal and state income taxes and expire in years 2005 through 2024. Under current tax law, the utilization of net operating loss and research and development and other tax credit carryforwards may be subject to limitations in the event of certain changes in ownership.

**10. Stockholders' Equity**

*The Offering*

In October 2003 the Company completed a public offering of 5,721,250 shares of its common stock and received net proceeds (after the underwriters discount but before deducting offering expenses) of \$51,147,975.

**AMERICAN SUPERCONDUCTOR CORPORATION**  
**NOTES TO CONSOLIDATED STATEMENTS—(Continued)**

*Stock Compensation Expense*

The composition of stock compensation expense in the Statement of Stockholder's Equity for the last three fiscal years was as follows:

	For the fiscal years ended March 31,		
	2004	2003	2002
401(k) Match	\$ 339,203	\$ 360,003	\$ 461,892
Employee Stock Awards	19,404	7,189	17,580
	<u>\$ 358,607</u>	<u>\$ 367,192</u>	<u>\$ 479,472</u>

*Stock-Based Compensation Plans*

The Company has six stock option plans including three Directors' Plans. The stock option plans (the Plans) include the 1987 Stock Plan (the 1987 Plan), the 1993 Stock Option Plan (the 1993 Plan), the 1996 Stock Incentive Plan (the 1996 Plan), the 1991 Director Stock Option Plan (the 1991 Director Plan), the 1994 Director Stock Option Plan (the 1994 Director Plan), and the Second Amended and Restated 1997 Director Stock Option Plan (the 1997 Director Plan). The Board of Directors authorized the issuance of 74,000 shares of restricted stock with a fair market value of \$636,400 to certain officers in fiscal year 2000. The shares are subject to restrictions on transfers and repurchase rights in favor of the Company; the restriction on sale can be removed upon meeting certain corporate performance targets or at the end of a six-year vesting period. The Company recorded expenses of \$75,184, \$106,067, and \$106,067 for the fiscal years ended 2004, 2003 and 2002, respectively, related to this issuance. The Board of Directors authorized an additional 31,000 shares of restricted stock in fiscal 2003 with a fair market value of \$193,440 to certain officers. The Company recorded expenses of \$32,244 in fiscal 2004 and 2003 related to this issuance. The Board of Directors authorized an additional 153,500 shares of restricted stock in fiscal 2004 with a fair market value of \$650,812 to certain officers and employees. The Company recorded expenses of \$154,650 in fiscal 2004 related to this issuance. Additionally, the Board of Directors authorized options for an additional 175,000 shares related to the acquisition of IE in fiscal 2001. All options issued under the IE plan are nonqualified. The Plans are administered by the Compensation Committee of the Board of Directors and permit the Company to sell or award common stock or to grant stock options for the purchase of common stock.

The Plans provide for the issuance of incentive stock options and non-qualified stock options to purchase the Company's common stock. In the case of incentive stock options, the exercise price shall be equal to at least the fair market value of the common stock, as determined by the Board of Directors, on the date of grant. The 1991, 1994 and 1997 Director Plans are stock option plans for members of the Board of Directors who are not also employees of the Company (outside directors). The 1997 Director Plan provides for the automatic grant of stock options for the purchase of common stock by outside directors at an exercise price equal to fair market value at the grant date. No further grants may be made under the 1987 Plan, the 1991 Director Plan, the 1993 Plan or the 1994 Director Plan, all of which have expired.

Options granted under the Plans, other than the Amended and Restated 1997 Director Stock Option Plan, generally become exercisable in equal annual increments over a three, four or five year period and expire 10 years from the date of grant or from two to three months after termination of employment.

**AMERICAN SUPERCONDUCTOR CORPORATION**  
**NOTES TO CONSOLIDATED STATEMENTS—(Continued)**

The following table summarizes information about stock options outstanding at March 31, 2004.

Range of Exercise Price	Outstanding			Exercisable	
	Number Outstanding At 3/31/04	Weighted Average Remaining Contractual Life	Weighted Average Exercise Price	Number Exercisable at 3/31/04	Weighted Average Exercise Price
\$ 0.00– 5.89	1,036,100	8.7	\$ 2.71	133,000	\$ 1.25
5.89–11.78	1,326,890	6.0	9.56	846,769	10.07
11.78–17.66	768,515	5.0	13.29	577,780	13.06
17.66–23.55	411,150	1.2	20.64	374,750	20.57
23.55–29.44	491,700	6.1	25.50	295,020	25.50
29.44–35.33	750,000	6.3	32.56	450,000	32.56
35.33–41.21	55,000	6.6	36.43	33,000	36.43
41.21–58.88	40,000	5.9	58.88	40,000	58.88
<b>\$ 0.00–58.88</b>	<b>4,879,355</b>	<b>6.1</b>	<b>\$ 15.48</b>	<b>2,750,319</b>	<b>\$ 18.06</b>

The following table summarizes the information concerning currently outstanding and exercisable options:

	Shares	Weighted average Exercise Price	Number Exercisable
Outstanding at March 31, 2001	4,586,809	\$ 18.93	1,515,347
Granted	857,050	13.30	
Exercised	(75,166)	9.59	
Canceled	(416,153)	14.35	
Outstanding at March 31, 2002	4,952,540	18.51	2,235,801
Granted	524,300	6.76	
Exercised	0	0.00	
Canceled	(806,925)	15.16	
Outstanding at March 31, 2003	4,669,915	17.77	2,656,323
Granted	1,033,650	3.83	
Exercised	(282,010)	9.31	
Canceled	(542,200)	16.20	
Outstanding at March 31, 2004	4,879,355	\$ 15.48	2,750,319
Available for grant at March 31, 2004:	852,695		

*Stock Purchase Warrants*

The Company recorded an increase to additional paid-in capital and a corresponding charge to deferred warrant costs of approximately \$336,000 in January 1998 related to the issuance of stock purchase warrants for 250,500 shares of common stock at an exercise price of \$10.20 per share which were exercisable over a five-year period following the date of grant. These warrants, which were not exercised, were granted in consideration of ongoing financial services being provided to the Company. Expense related to these warrants was approximately \$0, \$50,000, and \$67,000 for the fiscal years ended March 31, 2004, 2003 and 2002, respectively.

The Company also granted warrants in 1996 and 1998 to the Electric Power Research Institute (EPRI). See Note 12.



**AMERICAN SUPERCONDUCTOR CORPORATION**  
**NOTES TO CONSOLIDATED STATEMENTS—(Continued)**

**11. Commitments and Contingencies**

Under Delaware law, the Company is required to indemnify its officers and directors for liabilities incurred under certain circumstances. The term of the indemnification period is for the officer's or director's lifetime. The maximum potential amount of future payments the Company could be required to make is unlimited; however, the Company has a Director and Officer insurance policy that limits its indemnification exposure and enables it to recover a portion of any future amounts paid. As a result of its insurance policy coverage, the Company believes its indemnification exposure is minimal. These indemnification obligations were grandfathered under the provisions of FASB Interpretation No. (FIN) 45 as they were in effect prior to March 31, 2003. Accordingly, the Company has no liabilities recorded under FIN No. 45 as of March 31, 2004 or 2003.

The Company received notice on November 5, 2003 of a lawsuit filed against it by TM Capital Corp., a past financial advisor to the Company, under which TM Capital claims to be entitled to cash and equity compensation with respect to the Company's October 2003 public equity offering. Specifically, TM Capital is requesting a cash payment in excess of \$1,600,000 and warrants to purchase over 170,000 shares of the Company's common stock at an exercise price of \$9.50 per share. The Company filed an answer to this lawsuit, denying TM Capital's claims for damages and other relief and asserting several counterclaims against TM Capital, including breach of contract, gross negligence and breach of fiduciary duty. The lawsuit is currently in the early stages of discovery. As the Company believes it has meritorious defenses to this lawsuit and the Company cannot at this time conclude that potential losses associated with this litigation are probable based on SFAS No. 5, "Accounting for Contingencies", the Company has not recorded any liability on its balance sheet as of March 31, 2004 nor any expense to its Statement of Operations.

The Company rents its headquarters in Westborough, Massachusetts, under an operating lease, which expires in May 2009. In October 2000 the Company leased additional facilities in Westborough for the development of electric motor and generator technology under an operating lease that expires in 2005. The Company also rents an operating facility in Middleton, Wisconsin, under a lease which expires on December 31, 2006, and one facility in New Berlin, Wisconsin, under a lease which expires in 2011. As part of its restructuring, consolidation and cost cutting measures announced in March 2002, the Company is outsourcing requirements for low temperature superconductor (LTS) magnets used in its SMES systems and as a result ceased operations in one of its two buildings in Middleton, Wisconsin, comprising approximately 27,000 square feet. Under all leases, the Company pays for real estate taxes, certain insurance coverage and operating expenses.

Rent expense under the leases mentioned above was as follows:

	2004	2003	2002
Rent expense	\$ 3,113,000	\$ 2,043,000	\$ 1,994,000

Minimum future lease commitments at March 31, 2004 were as follows:

For the years ended March 31,	Total
2005	\$ 3,135,774
2006	2,983,289
2007	2,778,835
2008	2,623,637
2009 and beyond	4,235,575
Total	\$ 15,757,110

**AMERICAN SUPERCONDUCTOR CORPORATION**  
**NOTES TO CONSOLIDATED STATEMENTS—(Continued)**

In September 2002, the Company entered into a standby letter of credit arrangement with a financial institution to provide a guarantee for rent of \$1,000,000 for the Two Technology Drive facility in Westborough, Massachusetts. The letter of credit amount may be reduced to \$750,000 at June 1, 2005 and to \$500,000 at June 1, 2007. This letter of credit will expire on July 31, 2009.

**12. Research and Development Agreements**

The Company signed an agreement with Pirelli in February 2002 giving the Company the right to sell HTS wire to other cable manufacturers in addition to Pirelli in exchange for a \$2,250,000 one-time license payment, 50,000 shares of its stock (valued at \$6.91 per share), royalties on future such sales of wire, and the forgiveness of \$1,375,000 of accounts receivable. The agreement discontinued Pirelli's funding of the Company's research and development effective January 1, 2002. Under the previous agreement, Pirelli provided the Company with \$500,000 per quarter in research and development funding. The Pirelli alliance was originally established in February 1990; in the 12-year period between 1990 and March 31, 2002, the Company received development funding of approximately \$23,100,000 from Pirelli. The Company recorded revenues under this contract of \$0, \$0 and \$1,500,000 in fiscal years ended March 31, 2004, 2003 and 2002, respectively.

In March 1996, the Company entered into a strategic alliance with EPRI to develop and commercialize a coated conductor composite HTS wire. This agreement ended on March 31, 2000. In March 1996, under the first phase of the agreement, the Company granted a warrant for 100,000 shares of common stock (87,500 of which have been exercised) to EPRI at \$14.00 per share which became exercisable over a five-year period following the date of grant. In March 1998, under the second phase of the agreement, the Company granted to EPRI another warrant to purchase 110,000 shares of common stock (41,250 of which have been exercised) of the Company at \$13.94 per share, which became exercisable over a five-year period. The Company has received exclusive license rights to intellectual property from EPRI. The Company recorded an increase to additional paid-in capital and a corresponding charge to deferred contract costs of \$618,000 and \$637,000 in fiscal 1998 and 1997, respectively, relating to these warrants. Warrant expense related to these agreements was approximately \$0, \$71,000 and \$148,000 for the fiscal years ended March 31, 2004, 2003 and 2002, respectively.

**13. Cost Sharing Arrangements**

The Company has entered into several cost-sharing arrangements with various agencies of the United States government. Funds paid to the Company under these agreements are not reported as revenues but are used to directly offset the Company's research and development and selling, general and administrative expenses, and to purchase capital equipment. The Company recorded costs and funding under these agreements of \$6,253,000 and \$2,395,000, respectively, for fiscal 2004, of \$1,820,000 and \$764,000, respectively, for fiscal 2003 and of \$1,206,000 and \$603,000, respectively, for fiscal 2002. At March 31, 2004, total funding received to date under these agreements was \$16,573,000. Future funding expected to be received under existing agreements is approximately \$1,071,000 subject to continued future funding allocations.

**14. Employee Benefit Plans**

The Company has implemented a deferred compensation plan under Section 401(k) of the Internal Revenue Code. Any contributions by the Company are discretionary. The company instituted a stock match program in July 1998 under which the Company matched 25% of the first 4% of eligible contributions to the plan. Effective July 1, 2000 this contribution increased to 25% of the first 6% of eligible contributions. Effective July 1, 2001 this contribution increased to 35% of the first 6% of eligible contributions. The Company recorded expense of \$329,036, \$382,615 and \$437,401 in fiscal years 2004, 2003 and 2002, respectively, and corresponding charges to additional paid-in capital related to this program. The Company does not have post-retirement or post-employment benefit plans.

**AMERICAN SUPERCONDUCTOR CORPORATION**  
**NOTES TO CONSOLIDATED STATEMENTS—(Continued)**

The Company instituted an employee stock purchase plan (ESPP) on October 1, 2000. Employees purchase shares at a discount from fair market value every six months; this is a noncompensatory plan and accordingly no expense was recognized by the Company. Shares issued are recorded under “Issuance of Common Stock” in the Consolidated Statements of Stockholders Equity.

**15. Impairment of Long-lived Assets**

In the fourth quarter of fiscal 2003, in accordance with SFAS 144, the Company recorded charges totaling \$39.2 million for impairment of the group of long-lived assets associated with the AMSC Wires business segment, specifically the Devens wire manufacturing plant, the capital equipment in that plant, and first generation (1G) wire-related patents.

A number of factors indicated a potential impairment of the asset group, including substantial operating losses incurred and projected future losses associated with the AMSC Wires business segment, the Company’s intent to transition to the manufacture of second generation (2G) wire within the next several years and the Company’s market capitalization being less than the net book value for a significant period. In the fourth quarter of fiscal 2003, the Company revised its analysis of the probable timing of the transition to 2G wire, determining that the transition would be accelerated over previous expectations. The acceleration of the timing of the transition was the principal factor indicating a potential impairment.

To determine whether the asset group was impaired, the Company used a probability-weighted multiple scenario cash flow approach based on four potential scenarios that reflected a range of possible outcomes. The estimates used for future cash flows were based on producing and selling only 1G wire and excluded any costs or revenues that would be generated as a result of the transition to 2G wire. The success and timing for transitioning to a 2G wire manufacturing process remain uncertain. This uncertainty impacted the range of possible cash flow outcomes. The scenarios ranged from a long-term delay of the transition to 2G wire to successful introduction of 2G wire on an accelerated time-line. The Company believes that the most likely scenario is a successful transition to the 2G wire manufacturing process in the next several years.

On the basis of the probability-weighted cash flow analysis, the Company determined that the asset group was impaired and utilized a probability-weighted discounted cash flow as the best estimate of the fair value of the asset group. An impairment charge of \$39.2 million was recorded to write down the asset group to its estimated fair value.

In allocating the \$39.2 million impairment charge across the individual assets, the Company used an independent appraisal of the value of the property and plant as the current fair value for this asset, and assigned the remainder of the impairment charge on a pro rata basis between equipment and patents.

*Summary of Impairment Charge*

Building	\$ 17,642,105
Equipment	21,217,734
Patents (Other Assets)	371,038
	<hr/>
Total Impairment	\$ 39,230,877
	<hr/>

In conjunction with the impairment, the Company also reviewed and shortened the depreciable lives on the remaining net book value of the wires manufacturing equipment from 10 to six years.

**AMERICAN SUPERCONDUCTOR CORPORATION**  
**NOTES TO CONSOLIDATED STATEMENTS—(Continued)**

**16. Restructuring/Pirelli Charges**

*Workforce Reduction*

In March of fiscal 2002, a restructuring program resulted in the reduction of 99 full-time employees across all business functions at the Company's Massachusetts and Wisconsin locations. The workforce reductions were substantially completed in the fourth quarter of fiscal 2002, although nine affected employees were part of the Company's reported headcount as of March 31, 2002. The Company recorded a workforce reduction charge of \$1,548,897 relating primarily to severance and related benefits.

*Consolidation of Facilities*

In March of fiscal 2002, the Company recorded a charge of \$4,117,161 relating to the consolidation of the Company's Power Quality and Reliability business unit based in Middleton, Wisconsin with its Power Electronics business unit based in New Berlin, Wisconsin, into one new business unit called Power Electronic Systems. The total charge included \$2,826,403 related to the write-off of fixed assets and \$691,100 for a facility lease termination in Middleton, Wisconsin. The balance of \$599,658 related to cancelled purchase commitments. All such costs were recorded as restructuring costs.

*Accrued Restructuring Reserve*

The accrued restructuring reserve decreased from \$2,520,115 at March 31, 2002 to \$435,317 at March 31, 2003 to \$119,493 at March 31, 2004. The majority of the payments relating to the March 2002 restructuring were made in the fiscal year ended March 31, 2003, except for certain long-term contractual obligations on the Middleton, Wisconsin facility lease (which ended December 31, 2003) and on an equipment lease (which will end June 30, 2006).

*Pirelli License Costs*

In fiscal 2002, the Company recorded a charge of \$4,009,890 relating to the announcement of a license agreement with Pirelli to allow the Company to sell its HTS wire to other cable manufacturers in addition to Pirelli. The \$4,009,890 charge is shown as "Pirelli license costs" on the Consolidated Statements of Operations and is comprised of a \$2,250,000 cash license payment, 50,000 shares of the Company's common stock (valued at \$6.91 per share) that were issued in fiscal 2003, and the forgiveness of \$1,375,000 of accounts receivable.

Cash payments for the restructuring activities and other charges were completed within fiscal 2003, except for certain long-term contractual obligations such as the Middleton, Wisconsin facility lease payments through the end of the third quarter of fiscal 2004.

**17. Business Segment Information**

The Company has three reportable business segments—AMSC Wires, SuperMachines, and Power Electronic Systems.

The AMSC Wires business segment develops, manufactures and sells HTS wire. The focus of this segment's current development, manufacturing and sales efforts is on HTS wire for power transmission cables, motors, generators, synchronous condensers and specialty electromagnets.

The SuperMachines business segment develops and commercializes electric motors, generators, and synchronous condensers based on HTS wire. Its primary focus for motors and generators is on ship propulsion.

**AMERICAN SUPERCONDUCTOR CORPORATION**  
**NOTES TO CONSOLIDATED STATEMENTS—(Continued)**

The Power Electronic Systems business segment develops and sells power electronic converters and designs, manufactures and sells integrated systems based on those converters for power quality and reliability solutions and for wind farm applications.

The operating results for the three business segments are as follows:

Revenues*	Fiscal Year Ended March 31		
	2004	2003	2002
AMSC Wires	\$ 7,795,897	\$ 3,960,823	\$ 4,394,285
SuperMachines	26,501,073	6,125,151	5,839,895
Power Electronic Systems	7,011,735	10,934,318	1,415,920
<b>Total</b>	<b>\$ 41,308,705</b>	<b>\$ 21,020,292</b>	<b>\$ 11,650,100</b>

\* See Note 13. Cost share funding is not included in reported revenues.

Operating profit (loss)	Fiscal Year Ended March 31		
	2004	2003	2002
AMSC Wires	\$(18,815,738)	\$(66,727,224)	\$(26,143,475)
SuperMachines	966,130	(7,475,982)	(7,747,637)
Power Electronic Systems	(6,429,801)	(12,990,785)	(25,818,528)
Unallocated corporate expenses	(1,406,865)	(1,317,494)	(1,843,204)
<b>Total</b>	<b>\$(25,686,274)</b>	<b>\$(88,511,485)</b>	<b>\$(61,552,844)</b>

The assets for the three business segments (plus Corporate cash) are as follows:

	Fiscal Year Ended March 31	
	2004	2003
AMSC Wires	\$ 63,554,415	\$ 66,393,042
SuperMachines	6,018,468	4,992,328
Power Electronic Systems	7,679,370	10,544,397
Corporate cash and marketable securities	52,646,703	20,048,872
<b>Total</b>	<b>\$ 129,898,956</b>	<b>\$ 101,978,639</b>

Other significant segment information is as follows:

Depreciation and amortization	Fiscal Year Ended March 31		
	2004	2003	2002
AMSC Wires	\$ 6,001,724	\$ 6,709,830	\$ 3,776,152
SuperMachines	545,623	571,967	593,545
Power Electronic Systems	741,878	820,339	1,139,346
<b>Total</b>	<b>\$ 7,289,225</b>	<b>\$ 8,102,136</b>	<b>\$ 5,509,043</b>

Capital expenditures	Fiscal Year Ended March 31,	
	2004	2003
AMSC Wires	\$ 1,715,518	\$ 7,599,488
SuperMachines	166,953	66,835
Power Electronic Systems	74,737	132,912
<b>Total</b>	<b>\$ 1,957,208</b>	<b>\$ 7,799,235</b>

**AMERICAN SUPERCONDUCTOR CORPORATION**  
**NOTES TO CONSOLIDATED STATEMENTS—(Continued)**

The accounting policies of the business segments are the same as those described in Note 2, except that certain corporate expenses which we do not believe are specifically attributed or allocable to any of the three business segments have been excluded from the segment operating income (loss).

**18. Abandoned Debt Financing**

Fees—abandoned debt financing of \$1,387,857 for fiscal year ended March 31, 2004 represent various fees and expenses incurred in connection with the Company's previously-announced debt financing transaction that the Company decided not to pursue in August 2003 in favor of a public equity offering, which the Company completed in October 2003. None of these costs are related to the lawsuit filed against the Company in November 2003 by TM Capital Corp. See Note 11—Commitments and Contingencies.

**19. Quarterly Financial Data (Unaudited)**

Three Months Ended	Fiscal year ended March 31, 2004:			
	June 30, 2003	September 30, 2003	December 31, 2003	March 31, 2004
Revenues	\$ 7,756,000	\$ 9,614,000	\$ 12,302,000	\$ 11,637,000
Operating (loss)	\$ (8,420,000)	\$ (6,011,000)	\$ (6,606,000)	\$ (4,649,000)
Net loss	\$ (8,356,000)	\$ (7,336,000)	\$ (6,519,000)	\$ (4,522,000)
Net loss per common share	\$ (0.39)	\$ (0.34)	\$ (0.25)	\$ (0.16)

Three Months Ended	Fiscal year ended March 31, 2003:			
	June 30, 2002	September 30, 2002	December 31, 2002	March 31, 2003 *
Revenues	\$ 2,860,000	\$ 4,480,000	\$ 2,751,000	\$ 10,929,000
Operating (loss)	\$ (11,180,000)	\$ (10,502,000)	\$ (12,805,000)	\$ (54,024,000)
Net loss	\$ (10,829,000)	\$ (10,222,000)	\$ (12,615,000)	\$ (53,967,000)
Net loss per common share	\$ (0.53)	\$ (0.50)	\$ (0.60)	\$ (2.54)

\* See discussion on impairment charges in Note 15.

**20. New Accounting Pronouncements**

In January 2003, the FASB issued FIN 46, "Consolidation of Variable Interest Entities." In general, a variable interest entity is a corporation, partnership, trust or any other legal structure used for business purposes that either (a) does not have equity investors with voting rights or (b) has equity investors that do not provide sufficient financial resources for the entity to support its activities. A variable interest entity often holds financial assets, including loans or receivables, real estate or other property. Variable interest entities have been commonly referred to as special-purpose entities or off-balance sheet structures. This Interpretation requires a variable interest entity to be consolidated by a company if that company is subject to a majority of the risk of loss from the variable interest entity's activities or entitled to receive a majority of the entity's residual returns or both. In July 2003, the FASB added a limited-scope project to its agenda to modify FIN 46. In December 2003, the FASB released a revised version of FIN 46 (referred to as FIN 46R) clarifying certain aspects of FIN 46 and providing certain entities with exemptions from the requirements of FIN 46. FIN 46R requires the application of either FIN 46 or FIN 46R to all Special Purpose Entities (SPEs) created prior to February 1, 2003 at the end of the first interim or annual reporting period ending after December 15, 2003. All entities created after January 31, 2003

**AMERICAN SUPERCONDUCTOR CORPORATION**  
**NOTES TO CONSOLIDATED STATEMENTS—(Continued)**

were already required to be analyzed under FIN 46, and they must continue to do so, unless FIN 46R is adopted early. FIN 46R will be applicable to all non-SPEs created prior to February 1, 2003 at the end of the first interim or annual reporting period ending after March 15, 2004. The adoption of this Interpretation did not have a material effect on the Company's consolidated financial statements for the year ended March 31, 2004

In May 2003, the FASB issued SFAS No. 150, "Accounting for Certain Financial Instruments with Characteristics of both Liabilities and Equity". This accounting standard establishes standards for classifying and measuring certain financial instruments with characteristics of both liabilities and equity. It requires that certain financial instruments that were previously classified as equity now be classified as a liability. This accounting standard is effective for financial instruments entered into or modified after May 31, 2003, and otherwise at the beginning of the first interim period beginning after June 15, 2003. The adoption of this SFAS did not have a material effect on the Company's consolidated financial statements for the year ended March 31, 2004.

**AMERICAN SUPERCONDUCTOR CORPORATION**  
**CONSOLIDATED BALANCE SHEETS**

	September 30, 2004	March 31, 2004
	(Unaudited)	
<b>ASSETS</b>		
Current assets:		
Cash and cash equivalents	\$ 26,355,510	\$ 31,241,237
Short-term marketable securities	19,299,694	15,045,419
Accounts receivable, net	4,910,717	8,566,657
Inventory	10,659,050	4,889,394
Prepaid expenses and other current assets	737,003	906,956
	<hr/>	<hr/>
Total current assets	61,961,974	60,649,663
Property, plant and equipment:		
Land	4,021,611	4,021,611
Construction in progress—building and equipment	2,353,845	1,506,326
Building	34,102,138	34,102,138
Equipment	40,427,942	40,645,778
Furniture and fixtures	4,165,819	4,168,165
Leasehold improvements	6,269,197	6,269,037
	<hr/>	<hr/>
	91,340,552	90,713,055
Less: accumulated depreciation	(37,184,086)	(34,082,036)
	<hr/>	<hr/>
Property, plant and equipment, net	54,156,466	56,631,019
Long-term marketable securities	—	6,360,047
Goodwill	1,107,735	1,107,735
Other assets	5,656,263	5,150,492
	<hr/>	<hr/>
Total assets	\$ 122,882,438	\$ 129,898,956
	<hr/>	<hr/>
<b>LIABILITIES AND STOCKHOLDERS' EQUITY</b>		
Current liabilities:		
Accounts payable and accrued expenses	\$ 10,602,853	\$ 11,541,634
Deferred revenue	4,496,569	2,905,792
	<hr/>	<hr/>
Total current liabilities	15,099,422	14,447,426
Commitments and contingencies (Note 8)		
Stockholders' equity:		
Common stock, \$.01 par value		
Authorized shares—100,000,000; shares issued and outstanding 27,774,902 and 27,614,149 at September 30, 2004 and March 31, 2004, respectively	277,749	276,141
Additional paid-in capital	417,471,459	415,729,441
Deferred compensation	(987,406)	(701,524)
Deferred warrant costs	(28,594)	—
Accumulated other comprehensive loss	(77,152)	(9,337)
Accumulated deficit	(308,873,040)	(299,843,191)
	<hr/>	<hr/>
Total stockholders' equity	107,783,016	115,451,530
	<hr/>	<hr/>
Total liabilities and stockholders' equity	\$ 122,882,438	\$ 129,898,956
	<hr/>	<hr/>

The accompanying notes are an integral part of the consolidated financial statements.



**AMERICAN SUPERCONDUCTOR CORPORATION**  
**CONSOLIDATED STATEMENTS OF OPERATIONS**

	Three Months Ended September 30,		Six Months Ended September 30,	
	2004	2003	2004	2003
	(Unaudited)		(Unaudited)	
<b>Revenues:</b>				
Contract revenue	\$ 459,977	\$ 197,669	\$ 655,172	\$ 553,446
Product sales and prototype development contracts	9,072,760	9,416,684	21,527,641	16,817,214
<b>Total revenues</b>	<b>9,532,737</b>	<b>9,614,353</b>	<b>22,182,813</b>	<b>17,370,660</b>
<b>Costs and expenses:</b>				
Costs of revenue—contract revenue	512,799	186,482	696,947	522,122
Costs of revenue—product sales and prototype development contracts	9,043,884	9,960,116	22,530,062	18,232,905
Research and development	2,047,311	3,111,352	3,636,193	7,974,409
Selling, general and administrative	2,163,816	2,367,594	4,540,824	5,072,442
<b>Total costs and expenses</b>	<b>13,767,810</b>	<b>15,625,544</b>	<b>31,404,026</b>	<b>31,801,878</b>
Operating loss	(4,235,073)	(6,011,191)	(9,221,213)	(14,431,218)
Interest income	159,813	47,538	303,571	82,057
Fees—abandoned debt financing	—	(1,355,934)	(35,193)	(1,355,934)
Other income (expense), net	(8,421)	(16,669)	(77,014)	12,363
<b>Net loss</b>	<b>\$ (4,083,681)</b>	<b>\$ (7,336,256)</b>	<b>\$ (9,029,849)</b>	<b>\$ (15,692,732)</b>
<b>Net loss per common share</b>				
Basic and Diluted	\$ (0.15)	\$ (0.34)	\$ (0.33)	\$ (0.73)
<b>Weighted average number of common shares outstanding</b>				
Basic and Diluted	27,760,281	21,381,882	27,742,476	21,362,905

The accompanying notes are an integral part of the consolidated financial statements.

**AMERICAN SUPERCONDUCTOR CORPORATION**  
**CONSOLIDATED STATEMENTS OF COMPREHENSIVE LOSS**

	Three Months Ended September 30,		Six Months Ended September 30,	
	2004	2003	2004	2003
	(Unaudited)		(Unaudited)	
Net loss	\$ (4,083,681)	\$ (7,336,256)	\$ (9,029,849)	\$ (15,692,732)
Other comprehensive income (loss)				
Foreign currency translation	(108)	(2,805)	790	(11,964)
Unrealized gains (losses) on investments	49,695	2,581	(68,605)	5,956
Other comprehensive income (loss)	49,587	(224)	(67,815)	(6,008)
Comprehensive loss	\$ (4,034,094)	\$ (7,336,480)	\$ (9,097,664)	\$ (15,698,740)

The accompanying notes are an integral part of the consolidated financial statements.

**AMERICAN SUPERCONDUCTOR CORPORATION**  
**CONSOLIDATED STATEMENTS OF CASH FLOWS**

	Six Months Ended September 30,	
	2004	2003
	(Unaudited)	
Cash flows from operating activities:		
Net loss	\$ (9,029,849)	\$ (15,692,732)
Adjustments to reconcile net loss to net cash used in operations:		
Depreciation and amortization	3,884,101	3,609,038
Loss on disposal of PP&E and abandoned patents	192,720	36,071
Amortization of deferred compensation expense	196,530	119,963
Amortization of deferred warrant costs	5,946	26,646
Stock compensation expense	21,833	19,404
Changes in operating asset and liability accounts :		
Accounts receivable	3,655,940	(959,339)
Inventory-current and long-term	(5,769,656)	1,976,648
Prepaid expenses and other current assets	170,731	(65,305)
Accounts payable and accrued expenses	(938,781)	1,326,206
Deferred revenue—current and long-term	1,590,777	(912,847)
Net cash used in operating activities	(6,019,708)	(10,516,247)
Cash flows from investing activities:		
Purchase of property, plant and equipment	(891,463)	(1,106,582)
Proceeds from the sale of property, plant and equipment	55,500	31,935
Purchase of marketable securities	(18,268,209)	—
Proceeds from the sale of marketable securities	20,305,376	523,260
Increase in other assets	(1,272,064)	(391,283)
Net cash used in investing activities	(70,860)	(942,670)
Cash flows from financing activities:		
Net proceeds from issuance of common stock	1,204,841	745,391
Net cash provided by financing activities	1,204,841	745,391
Net decrease in cash and cash equivalents	(4,885,727)	(10,713,526)
Cash and cash equivalents at beginning of period	31,241,237	18,487,752
Cash and cash equivalents at end of period	\$ 26,355,510	\$ 7,774,226
Supplemental schedule of cash flow information:		
Noncash issuance of common stock	\$ 218,363	\$ 139,367

The accompanying notes are an integral part of the consolidated financial statements.

**AMERICAN SUPERCONDUCTOR CORPORATION**  
**NOTES TO INTERIM CONSOLIDATED FINANCIAL STATEMENTS**

**1. Nature of the Business:**

American Superconductor Corporation (the Company or AMSC) was formed on April 9, 1987. The Company is focused on developing, manufacturing and selling products using two core technologies: high temperature superconductor (HTS) wires and power electronic converters for electric power applications. The Company also assembles superconductor wires and power electronic converters into fully-integrated products, such as HTS ship propulsion motors and dynamic reactive compensation systems, which the Company sells or plans to sell to end users. The Company operates in three business segments—AMSC Wires, SuperMachines and Power Electronic Systems.

The Company has generated operating losses since its inception in 1987 and expects to continue incurring losses until at least the end of fiscal 2005. Operating losses for the fiscal years ended March 31, 2004, 2003 and 2002 have contributed to net cash used by operating activities of \$17,421,953, \$39,604,957 and \$26,456,387, respectively, for these periods. For the six months ended September 30, 2004, net cash used by operating activities was \$6,019,708.

The Company had cash, cash equivalents, and short-term marketable securities of \$45,655,204 as of September 30, 2004.

The Company currently derives a portion of its revenue from research and development contracts. The Company recorded contract revenue related to research and development contracts of \$459,977 and \$197,669 for the six months ended September 30, 2004 and 2003, respectively, and \$655,172 and \$553,446 for the six months ended September 30, 2004 and 2003, respectively. In addition, the Company recorded prototype development contract revenue on U.S. Navy and other contracts of \$3,600,352 and \$6,643,755 for the six months ended September 30, 2004 and 2003, respectively, and \$11,073,972 and \$12,193,649 for the six months ended September 30, 2004 and 2003, respectively, which are included under “Revenues – Product sales and prototype development contracts.”

Costs of revenue include research and development (R&D) and selling, general, and administrative (SG&A) expenses that are incurred in the performance of these development contracts.

R&D and SG&A expenses included as costs of revenue for these development contracts were as follows:

	Three Months Ended September 30,		Six Months Ended September 30,	
	2004	2003	2004	2003
	(Unaudited)		(Unaudited)	
R&D expenses	\$ 5,143,865	\$ 6,685,255	\$ 13,967,038	\$ 11,439,342
SG&A expenses	\$ 1,061,954	\$ 1,602,198	\$ 3,063,930	\$ 3,126,851

**2. Basis of Presentation:**

The accompanying consolidated financial statements have been prepared in accordance with generally accepted accounting principles. The unaudited consolidated financial statements of the Company presented herein have been prepared in accordance with the Securities and Exchange Commission’s (SEC) instructions to Form 10-Q and as such do not include all of the information and note disclosures included in annual financial statements prepared in accordance with generally accepted accounting principles. Certain information and footnote disclosure normally included in the Company’s annual consolidated financial statements have been condensed or omitted. The interim consolidated financial statements, in the opinion of management, reflect all adjustments (consisting of normal recurring accruals) necessary for a fair presentation of the results for the interim periods ended September 30, 2004 and 2003 and the financial position at September 30, 2004.

**AMERICAN SUPERCONDUCTOR CORPORATION**  
**NOTES TO INTERIM CONSOLIDATED FINANCIAL STATEMENTS—(Continued)**

The results of operations for the interim periods are not necessarily indicative of the results of operations to be expected for the fiscal year. The Company suggests that these interim consolidated financial statements be read in conjunction with the audited consolidated financial statements for the fiscal year ended March 31, 2004 which are contained in the Company's Annual Report on Form 10-K covering the fiscal year ended March 31, 2004.

There has been no material change to the Company's significant accounting policies from those described in the Form 10-K for the year ended March 31, 2004.

**3. Stock-Based Compensation Plans and Pro Forma Stock-Based Compensation Expense**

The Company applies Accounting Principles Board Opinion (APB) No. 25, "Accounting for Stock Issued to Employees," and related interpretations in accounting for its stock-based compensation plans. Accordingly, no accounting recognition is given to stock options granted at fair market value until they are exercised. Upon exercise, net proceeds, including tax benefits realized, are credited to stockholders' equity.

In October 1995, the FASB issued SFAS No. 123, "Accounting for Stock-Based Compensation," which sets forth a fair-value-based method of recognizing stock-based compensation expense. As permitted by SFAS No. 123, the Company has elected to continue to apply APB No. 25 to account for its stock-based compensation plans.

Had compensation cost for awards granted after 1994 under the Company's stock-based compensation plan been determined based on the fair value at the grant dates consistent with the method set forth under SFAS No. 123, the effect on certain financial information of the Company would have been as follows:

	For the three months ended September 30,		For the six months ended September 30,	
	2004	2003	2004	2003
Net loss	\$ (4,083,681)	\$ (7,336,256)	\$ (9,029,849)	\$ (15,692,732)
Add: Stock compensation expense under APB 25	101,688	65,961	196,530	119,963
Less: Stock compensation, net of tax, had all options been recorded at fair value per SFAS 123	(1,111,669)	(949,757)	(2,141,296)	(1,899,515)
Pro forma net loss	<u>\$ (5,093,662)</u>	<u>\$ (8,220,052)</u>	<u>\$ (10,974,615)</u>	<u>\$ (17,472,284)</u>
Weighted average shares, basic and diluted	27,760,281	21,381,882	27,742,476	21,362,905
Net loss per share, as reported	\$ (0.15)	\$ (0.34)	\$ (0.33)	\$ (0.73)
Net loss per share, pro forma	\$ (0.18)	\$ (0.38)	\$ (0.40)	\$ (0.82)

**AMERICAN SUPERCONDUCTOR CORPORATION**  
**NOTES TO INTERIM CONSOLIDATED FINANCIAL STATEMENTS—(Continued)**

The adjusted amounts include the effects of all activity under the Company's stock-based compensation plans since April 1, 2000. The fair value of each option grant is estimated on the date of grant using the Black-Scholes option pricing model with the following assumptions used for grants:

	For the three months ended September 30,		For the six months ended September 30,	
	2004	2003	2004	2003
Dividend yield	None	None	None	None
Expected volatility	50.18%	100%	44.65%	100%
Risk-free interest rate	3.0%	4.0%	3.0%	4.0%
Expected life (years)	6.5	6.5	6.5	6.5
	For the three months ended September 30,		For the six months ended September 30,	
	2004	2003	2004	2003
Weighted average fair value of options granted at fair market value	\$ 6.42	N/A	\$ 6.68	\$ 2.87

The above amounts may not be indicative of future expense because amounts are recognized over the vesting period and the Company expects it will have additional grants and related activity under these plans in the future.

**4. Net Loss Per Common Share:**

Basic earnings per share ("EPS") is computed by dividing net income/(loss) available to common stockholders by the weighted-average number of common shares outstanding for the period. Diluted EPS is computed using the weighted average number of common shares and dilutive common equivalent shares outstanding during the period. Common equivalent shares include the effect of the exercise of stock options and warrants. For the six months ended September 30, 2004 and 2003, common equivalent shares of 2,483,725 and 3,430,830 were not included in the calculation of diluted EPS as their effect was antidilutive. For the six months ended September 30, 2004 and 2003, common equivalent shares of 2,378,946 and 4,074,330 were not included in the calculation of diluted EPS as their effect was antidilutive.

**5. Accounts Receivable:**

Accounts receivable at September 30, 2004 and March 31, 2004 consisted of the following:

	September 30, 2004	March 31, 2004
Accounts Receivable (billed)	\$ 2,377,943	\$ 3,427,482
Accounts Receivable (unbilled)	2,532,774	5,180,524
Less: Allowance for Doubtful Accounts	—	(41,349)
Accounts Receivable, net	<u>\$ 4,910,717</u>	<u>\$ 8,566,657</u>

**AMERICAN SUPERCONDUCTOR CORPORATION**  
**NOTES TO INTERIM CONSOLIDATED FINANCIAL STATEMENTS—(Continued)**

**6. Inventories:**

Inventories at September 30, 2004 and March 31, 2004 consisted of the following:

	September 30, 2004	March 31, 2004
Raw materials	\$ 478,371	\$ 623,792
Work-in-progress	3,286,776	2,109,794
Finished goods	3,803,271	2,155,808
Deferred program costs	3,090,632	—
<b>Inventory, net</b>	<b>\$ 10,659,050</b>	<b>\$ 4,889,394</b>

Deferred program costs of \$3,090,632 represent costs incurred in excess of funding as of September 30, 2004 on a program to build a 36.5 megawatt (MW) motor for the U.S. Navy. These costs were recorded as inventory as of September 30, 2004, as future funding was deemed probable. On October 12, 2004, funding in excess of the inventoried cost was received from the Navy, at which time the revenue was recognized and the deferred program costs relieved from inventory in the third quarter of fiscal 2005.

**7. Accounts Payable and Accrued Expenses**

Accounts payable and accrued expenses at September 30, 2004 and March 31, 2004 consisted of the following:

	September 30, 2004	March 31, 2004
Accounts payable	\$ 4,353,897	\$ 4,408,212
Accrued restructuring	93,746	119,493
Accrued employee stock purchase plan	220,434	189,659
Accrued expenses	5,277,695	6,100,914
Accrued vacation	657,081	723,356
<b>Accounts payable and accrued expenses</b>	<b>\$ 10,602,853</b>	<b>\$ 11,541,634</b>

**8. Commitments and Contingencies**

Under Delaware law and the Company's By-laws, the Company is required to indemnify its officers and directors for liabilities incurred under certain circumstances. The term of the indemnification period is for the officer's or director's lifetime. The maximum potential amount of future payments the Company could be required to make is unlimited; however, the Company has a Director and Officer insurance policy that limits its indemnification exposure and enables it to recover a portion of any future amounts paid. As a result of its insurance policy coverage, the Company believes its indemnification exposure is minimal. These indemnification obligations were grandfathered under the provisions of FASB Interpretation No. (FIN) 45 as they were in effect prior to March 31, 2003. Accordingly, the Company has no liabilities recorded under FIN No. 45 as of September 30, 2004.

The Company received notice on November 5, 2003 of a lawsuit filed against it by TM Capital Corp., a past financial advisor to the Company, under which TM Capital claims to be entitled to cash and equity compensation with respect to the Company's October 2003 public equity offering. Specifically, TM Capital is requesting a cash payment in excess of \$1,600,000 and warrants to purchase over 170,000 shares of the Company's common stock at an exercise price of \$9.50 per share. The Company filed an answer to this lawsuit, denying TM Capital's

**AMERICAN SUPERCONDUCTOR CORPORATION**  
**NOTES TO INTERIM CONSOLIDATED FINANCIAL STATEMENTS—(Continued)**

claims for damages and other relief and asserting several counterclaims against TM Capital, including breach of contract, gross negligence and breach of fiduciary duty. The lawsuit is currently in the early stages of discovery. As the Company believes it has meritorious defenses to this lawsuit and the Company cannot at this time conclude that potential losses associated with this litigation are probable or reasonably estimatable based on SFAS No. 5, "Accounting for Contingencies," the Company has not recorded any liability on its balance sheet as of September 30, 2004 nor any expense to its Statement of Operations.

**9. Cost-Sharing Arrangements:**

The Company has entered into several cost-sharing arrangements with various agencies of the United States government. Funds paid to the Company under these agreements are not reported as revenues but are used to directly offset a portion of the Company's R&D and SG&A expenses, and to purchase capital equipment. The Company recorded costs under these agreements of \$1,046,638 and \$1,399,208 for the six months ended September 30, 2004 and 2003, respectively. For the six months ended September 30, 2004 and 2003, the Company recorded costs of \$2,204,848 and \$2,444,474, respectively. The Company recorded funding under these agreements of \$561,052 and \$446,713 for the six months ended September 30, 2004 and 2003, respectively. For the six months ended September 30, 2004 and 2003, the Company recorded funding of \$1,067,140 and \$759,432, respectively. At September 30, 2004, total funding received inception to date under these agreements was \$17,640,000. Future funding expected to be received under the existing agreements is approximately \$1,004,000, subject to continued future funding allocations.

**10. Business Segment Information:**

The Company has three reportable business segments—AMSC Wires, SuperMachines, and Power Electronic Systems.

The AMSC Wires business segment develops, manufactures and sells HTS wire. The focus of this segment's current development, manufacturing and sales efforts is on HTS wire for power transmission cables, motors, generators, synchronous condensers and specialty electromagnets.

The SuperMachines business segment develops and commercializes electric motors, generators, and synchronous condensers based on HTS wire. Its primary focus for motors and generators is on ship propulsion.

The Power Electronic Systems business segment develops and sells power electronic converters and designs, manufactures and sells integrated systems based on those converters for power quality and reliability solutions and for wind farm applications.

The operating results for the three business segments are as follows:

	Three Months Ended September 30,		Six Months Ended September 30,	
	2004	2003	2004	2003
<b>Revenues*</b>				
AMSC Wires	\$ 3,062,418	\$ 2,361,334	\$ 6,396,567	\$ 3,458,458
SuperMachines	3,553,353	6,407,755	10,939,084	11,957,649
Power Electronic Systems	2,916,966	845,264	4,847,162	1,954,553
<b>Total</b>	<b>\$ 9,532,737</b>	<b>\$ 9,614,353</b>	<b>\$ 22,182,813</b>	<b>\$ 17,370,660</b>

\* See Note 9. Cost sharing funding is not included in reported revenues.



**AMERICAN SUPERCONDUCTOR CORPORATION**  
**NOTES TO INTERIM CONSOLIDATED FINANCIAL STATEMENTS—(Continued)**

	Three Months Ended September 30,		Six Months Ended September 30,	
	2004	2003	2004	2003
<b>Operating income (loss)</b>				
AMSC Wires	\$ (3,100,805)	\$ (4,701,708)	\$ (5,989,807)	\$ (11,035,383)
SuperMachines	(81,571)	498,303	(378,298)	510,161
Power Electronic Systems	(473,245)	(1,454,825)	(1,822,091)	(3,278,890)
Unallocated corporate expenses	(579,452)	(352,961)	(1,031,017)	(627,106)
<b>Total</b>	<b>\$ (4,235,073)</b>	<b>\$ (6,011,191)</b>	<b>\$ (9,221,213)</b>	<b>\$ (14,431,218)</b>

The assets for the three business segments (plus Corporate Cash) are as follows:

	For the period ended	
	September 30, 2003	March 31, 2004
<b>Assets</b>		
AMSC Wires	\$ 62,685,325	\$ 63,554,415
SuperMachines	6,960,848	6,018,468
Power Electronic Systems	7,581,061	7,679,370
Corporate cash and marketable securities	45,655,204	52,646,703
<b>Total</b>	<b>\$ 122,882,438</b>	<b>\$ 129,898,956</b>

The accounting policies of the business segments are the same as those for the consolidated Company, except that certain corporate expenses which the Company does not believe are specifically attributable or allocable to any of the three business segments have been excluded from the segment operating income (loss).

#### 11. New Accounting Pronouncements

In March 2004, the Emerging Issues Task Force (EITF) reached a consensus on EITF No. 03-01, "The Meaning of Other-Than Temporary Impairment and its Application to Certain Investments." EITF No. 03-01 addresses disclosures about unrealized losses on available-for-sale debt and equity securities and the evaluation of other-than temporary impairment related to securities accounted for under FASB Statement No. 115, "Accounting for Certain Investments in Debt and Equity Securities." The provisions of EITF No. 03-01 are effective for other-than temporary impairment evaluations and disclosures in fiscal periods beginning after June 15, 2004. The adoption of EITF No. 03-01 had no impact on the Company's financial position or operating results.



**PART II**  
**INFORMATION NOT REQUIRED IN PROSPECTUS**

**Item 14. Other Expenses of Issuance and Distribution.**

The following table sets forth the expenses expected to be incurred by American Superconductor in connection with the registration and distribution of the securities registered hereby, all of which expenses will be borne by American Superconductor. Except for the SEC registration fee and NASD filing fee, all such expenses are estimated.

	<u>Amount</u>
SEC registration fee	\$ 6,952
NASD filing fee	\$ 6,407
Printing expenses	
Legal fees and expenses	
Accounting fees and expenses	
NASDAQ National Market fees	
Miscellaneous expenses	
	<hr/>
Total	\$ <hr/>

**Item 15. Indemnification of Directors and Officers.**

Section 145 of the General Corporation Law of Delaware provides that a corporation has the power to indemnify a director, officer, employee or agent of the corporation and certain other persons serving at the request of the corporation in related capacities against amounts paid and expenses incurred in connection with an action or proceeding to which he is or is threatened to be made a party by reason of such position, if such person shall have acted in good faith and in a manner he reasonably believed to be in or not opposed to the best interests of the corporation, and, in any criminal proceeding, if such person had no reasonable cause to believe his conduct was unlawful; provided that, in the case of actions brought by or in the right of the corporation, no indemnification shall be made with respect to any matter as to which such person shall have been adjudged to be liable to the corporation unless and only to the extent that the adjudicating court determines that such indemnification is proper under the circumstances.

Article VI of the registrant's By-laws provides that a director or officer of the registrant (a) shall be indemnified by the registrant against all expenses (including attorneys' fees), judgments, fines and amounts paid in settlement actually and reasonably incurred in connection with any litigation or other legal proceeding (other than an action by or in the right of the registrant) brought against him by virtue of his position as a director or officer of the registrant if he acted in good faith and in a manner he reasonably believed to be in or not opposed to the best interests of the registrant, and, with respect to any criminal action or proceeding, had no reasonable cause to believe his conduct was unlawful and (b) shall be indemnified by the registrant against expenses (including attorneys' fees) incurred in connection with the defense or settlement of any action or suit by or in the right of the registrant by virtue of his position as a director or officer of the registrant if he acted in good faith and in a manner he reasonably believed to be in or not opposed to the best interests of the registrant, except that no indemnification shall be made with respect to any such matter as to which such director or officer shall have been adjudged to be liable to the registrant, unless and only to the extent that a court determines upon application that, despite the adjudication of liability but in view of all the circumstances of the case, such person is fairly and reasonably entitled to indemnity for such expenses as the court deems proper. Notwithstanding the foregoing, to the extent that a director or officer has been successful, on the merits or otherwise, he shall be indemnified against expenses (including attorneys' fees) actually and reasonably incurred by him in connection therewith. Expenses incurred in defending a civil or criminal action, suit or proceeding may be paid by the registrant upon receipt of an undertaking by the director or officer to repay such amount if the registrant ultimately determines that he is not entitled to indemnification.

## Table of Contents

Indemnification shall be made by the registrant upon a determination that the applicable standard of conduct required for indemnification has been met and that indemnification of a director or officer is proper. Such determination shall be made (a) by the Board of Directors by a majority vote of a quorum consisting of directors who were not parties to the action, or (b) if such a quorum is not obtainable, or if a quorum of disinterested directors so directs, by independent legal counsel in a written opinion, or (c) by the stockholders of the registrant.

Article VI of the registrant's By-laws further provides that the indemnification provided therein is not exclusive, and provides that to the extent the Delaware General Corporation Law is amended or supplemented, Article V shall be amended automatically and construed so as to permit indemnification and advancement of expenses to the fullest extent permitted by such law.

Article EIGHTH of the registrant's Certificate of Incorporation provides that no director of the registrant shall be personally liable to the registrant or its stockholders for monetary damages for breach of fiduciary duty as a director, provided, that a director shall remain liable (i) for any breach of such director's duty of loyalty to the registrant or its stockholders, (ii) for acts or omissions not in good faith or which involve intention misconduct or a knowing violation of law, (iii) for participation in a Board of Directors' action authorizing an unlawful dividend or unlawful stock purchase or redemption under Section 174 of the Delaware General Corporation Law, or (iv) for any transaction from which such director derived an improper personal benefit.

The registrant has a directors and officers liability insurance policy covering certain liabilities that may be incurred by its directors and officers.

### **Item 16. Exhibits.**

The following exhibits are filed with this registration statement.

<u>Exhibit Number</u>	<u>Description</u>
1.1	Form of Underwriting Agreement (1)
4.1a	Restated Certificate of Incorporation of the registrant (2)
4.1b	Certificate of Amendment of Restated Certificate of Incorporation of the registrant. (3)
4.2	Amended and Restated By-Laws of the registrant. (4)
4.3	Form of common stock certificate. (5)
4.4	Rights Agreement dated as of October 30, 1998 between the registrant and American Stock Transfer & Trust Company, as Rights Agent (6).
4.5	Amendment No. 1 to Rights Agreement dated as of January 29, 1999 between the registrant and American Stock Transfer & Trust Company, as Rights Agent (7).
5.1	Opinion of Wilmer Cutler Pickering Hale and Dorr LLP.
23.1	Consent of Wilmer Cutler Pickering Hale and Dorr LLP (included in the opinion filed as Exhibit 5.1).
23.2	Consent of PricewaterhouseCoopers LLP.
24.1	Powers of Attorney (included on signature pages).

(1) To be filed by amendment.

(2) Incorporated by reference to Exhibits to the registrant's Registration Statement on Form S-3, as amended (File No. 333-95261).

(3) Incorporated by reference to Exhibits to the registrant's Quarterly Report of Form 10-Q filed with the Commission on August 9, 2004 (Commission File No. 000-19672).

## Table of Contents

- (4) Incorporated by reference to Exhibits to the registrant's Quarterly Report on Form 10-Q filed with the Commission on November 14, 2000 (Commission File No. 000-19672).
- (5) Incorporated by reference to Exhibits to the registrant's Registration Statement on Form S-1, as amended (File No. 33-43647).
- (6) Incorporated by reference to Exhibit to the registrant's Registration Statement on Form 8-A filed with the Commission on November 2, 1998 (Commission File No. 000-19672).
- (7) Incorporated by reference to Exhibit to the registrant's Registration Statement on Form 8-A/A filed with the Commission on March 12, 1999 (Commission File No. 000-19672).

### **Item 17. Undertakings.**

The undersigned registrant hereby undertakes that, for purposes of determining any liability under the Securities Act of 1933, each filing of the registrant's annual report pursuant to Section 13(a) or 15(d) of the Securities Exchange Act of 1934 (and, where applicable, each filing of an employee benefit plan's annual report pursuant to Section 15(d) of the Securities Exchange Act of 1934) that is incorporated by reference in the registration statement shall be deemed to be a new registration statement relating to the securities offered therein, and the offering of such securities at that time shall be deemed to be the initial *bona fide* offering thereof.

Insofar as indemnification for liabilities arising under the Securities Act of 1933 may be permitted to directors, officers and controlling persons of the registrant pursuant to the foregoing provisions, or otherwise, the registrant has been advised that in the opinion of the Securities and Exchange Commission such indemnification is against public policy as expressed in the Act and is, therefore, unenforceable. In the event that a claim for indemnification against such liabilities (other than the payment by the registrant of expenses incurred or paid by a director, officer or controlling person of the registrant in the successful defense of any action, suit or proceeding) is asserted by such director, officer or controlling person in connection with the securities being registered, the registrant will, unless in the opinion of its counsel the matter has been settled by controlling precedent, submit to a court of appropriate jurisdiction the question whether such indemnification by it is against public policy as expressed in the Act and will be governed by the final adjudication of such issue.

The undersigned registrant hereby undertakes that:

(1) For purposes of determining any liability under the Securities Act of 1933, the information omitted from the form of prospectus filed as part of this registration statement in reliance upon Rule 430A and contained in a form of prospectus filed by the registrant pursuant to Rule 424(b)(1) or (4) or 497(h) under the Securities Act shall be deemed to be part of this registration statement as of the time it was declared effective.

(2) For the purpose of determining any liability under the Securities Act of 1933, each post-effective amendment that contains a form of prospectus shall be deemed to be a new registration statement relating to the securities offered therein, and the offering of such securities at that time shall be deemed to be the initial *bona fide* offering thereof.



[Table of Contents](#)

<u>Signature</u>	<u>Title</u>	<u>Date</u>
<hr/> <i>/s/ PETER O. CRISP</i> <hr/> <b>Peter O. Crisp</b>	Director	January 10, 2005
<hr/> <i>/s/ RICHARD DROUIN</i> <hr/> <b>Richard Drouin</b>	Director	January 10, 2005
<hr/> <i>/s/ ANDREW G.C. SAGE, II</i> <hr/> <b>Andrew G.C. Sage, II</b>	Director	January 10, 2005
<hr/> <i>/s/ JOHN B. VANDER SANDE</i> <hr/> <b>John B. Vander Sande</b>	Director	January 10, 2005

**EXHIBIT INDEX**

<u>Exhibit Number</u>	<u>Description</u>
1.1	Form of Underwriting Agreement (1)
4.1a	Restated Certificate of Incorporation of the registrant, as amended. (2)
4.1b	Certificate of Amendment of Restated Certificate of Incorporation of the registrant. (3)
4.2	Amended and Restated By-Laws of the registrant. (4)
4.3	Form of common stock certificate. (5)
4.4	Rights Agreement dated as of October 30, 1998 between the registrant and American Stock Transfer & Trust Company, as Rights Agent (6).
4.5	Amendment No. 1 to Rights Agreement dated as of January 29, 1999 between the registrant and American Stock Transfer & Trust Company, as Rights Agent (7).
5.1	Opinion of Wilmer Cutler Pickering Hale and Dorr LLP.
23.1	Consent of Wilmer Cutler Pickering Hale and Dorr LLP (included in the opinion filed as Exhibit 5.1).
23.2	Consent of PricewaterhouseCoopers LLP.
24.1	Powers of Attorney (included on signature pages).

(1)	To be filed by amendment.
(2)	Incorporated by reference to Exhibits to the registrant's Registration Statement on Form S-3, as amended (File No. 333-95261).
(3)	Incorporated by reference to Exhibits to the registrant's Quarterly Report on Form 10-Q filed with the Commission on August 9, 2004 (Commission File No. 000-19672).
(4)	Incorporated by reference to Exhibits to the registrant's Quarterly Report on Form 10-Q filed with the Commission on November 14, 2000 (Commission File No. 000-19672).
(5)	Incorporated by reference to Exhibits to the registrant's Registration Statement on Form S-1, as amended (File No. 33-43647).
(6)	Incorporated by reference to Exhibit to the registrant's Registration Statement on Form 8-A filed with the Commission on November 2, 1998 (Commission File No. 000-19672).
(7)	Incorporated by reference to Exhibit to the registrant's Registration Statement on Form 8-A/A filed with the Commission on March 12, 1999 (Commission File No. 000-19672).



January 10, 2005

American Superconductor Corporation  
Two Technology Drive  
Westborough, MA 01581

Re: Registration Statement on Form S-3

Ladies and Gentlemen:

This opinion is furnished to you in connection with a Registration Statement on Form S-3 (the "Registration Statement") filed with the Securities and Exchange Commission (the "Commission") under the Securities Act of 1933, as amended (the "Securities Act"), for the registration of 4,600,000 shares of Common Stock, \$.01 par value per share (the "Shares"), of American Superconductor Corporation, a Delaware corporation (the "Company"), including 600,000 Shares issuable upon exercise of an over-allotment option granted by the Company.

The Shares are to be sold by the Company pursuant to an underwriting agreement (the "Underwriting Agreement") to be entered into by and among the Company and Needham & Co., William Blair & Company, L.L.C. and RBC Capital Markets Corporation, as representatives of the several underwriters named in the Underwriting Agreement, the form of which will be filed as Exhibit 1.1 to the Registration Statement.

We are acting as counsel for the Company in connection with the issue and sale by the Company of the Shares. We have examined signed copies of the Registration Statement as filed with the Commission. We have also examined and relied upon minutes of meetings of the stockholders and the Board of Directors of the Company as provided to us by the Company, stock record books of the Company as provided to us by the Company, the Certificate of Incorporation and By-Laws of the Company, each as restated and/or amended to date, and such other documents as we have deemed necessary for purposes of rendering the opinions hereinafter set forth.

In our examination of the foregoing documents, we have assumed the genuineness of all signatures, the authenticity of all documents submitted to us as originals, the conformity to original documents of all documents submitted to us as copies, the authenticity of the originals of such latter documents and the legal competence of all signatories to such documents.

We express no opinion herein as to the laws of any state or jurisdiction other than the state laws of the Commonwealth of Massachusetts, the General Corporation Law of the State of Delaware and the federal laws of the United States of America.

Based upon and subject to the foregoing, we are of the opinion that the Shares have been duly authorized for issuance and, when the Shares are issued and paid for in accordance with the terms and conditions of the Underwriting Agreement, the Shares will be validly issued, fully paid and nonassessable.

Please note that we are opining only as to the matters expressly set forth herein, and no opinion should be inferred as to any other matters. This opinion is based upon currently existing statutes, rules, regulations and judicial decisions, and we disclaim any obligation to advise you of any change in any of these sources of law or subsequent legal or factual developments which might affect any matters or opinions set forth herein.

We hereby consent to the filing of this opinion with the Commission as an exhibit to the Registration Statement in accordance with the requirements of Item 601(b)(5) of Regulation S-K under the Securities Act and to the use of our name therein and in the related Prospectus under the caption "Legal Matters." In giving such consent, we do not hereby admit that we are in the category of persons whose consent is required under Section 7 of the Securities Act or the rules and regulations of the Commission.

Very truly yours,

WILMER CUTLER PICKERING  
HALE AND DORR LLP

By:                     /S/ PATRICK J. RONDEAU                      
                    Patrick J. Rondeau, Partner

**CONSENT OF INDEPENDENT REGISTERED PUBLIC ACCOUNTING FIRM**

We hereby consent to the use in this Registration Statement on Form S-3 of our report dated May 5, 2004 relating to the financial statements of American Superconductor Corporation, which appears in such Registration Statement. We also consent to the incorporation by reference of our report dated May 5, 2004 relating to the financial statements, and our report dated May 5, 2004 relating to the financial statement schedule, which appear in American Superconductor Corporation's Annual Report on Form 10-K for the year ended March 31, 2004. We also consent to the references to us under the headings "Experts" and "Selected Consolidated Financial Data" in such Registration Statement.

/s/ PricewaterhouseCoopers LLP

Boston, Massachusetts  
January 10, 2005